



EPS

Escola Politècnica
Superior

Projecte/Treball Fi de Carrera

Estudi: Enginyeria Industrial. Pla 2002

Títol: Disseny i desenvolupament d'un sistema de monitorització en continu de la qualitat de l'aigua de riu

Document: Plànols

Alumne: Laura Estorch Vigas

Director/Tutor: Jordi Comas Baron

Departament: Eng. Mecànica i de la Construcció Industrial

Àrea: Enginyeria de la construcció

Convocatòria (mes/any): Juny 2014

Índex

1. Filtre 10x10 mm.....	1
2. Filtre 5x5 mm.....	2
3. Filtre 2x2 mm.....	3
4. Prototip dipòsit.....	4

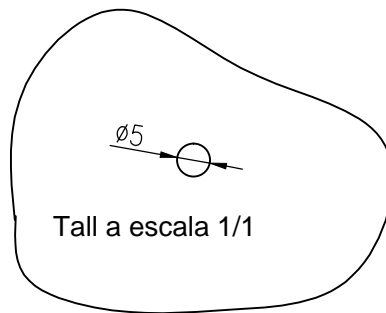
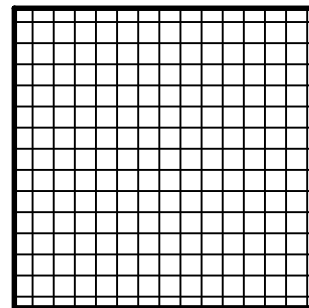
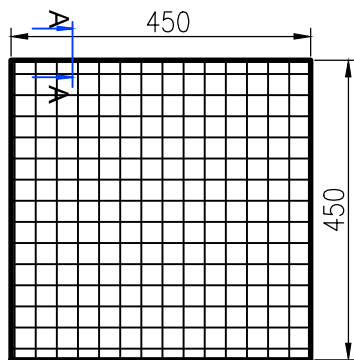
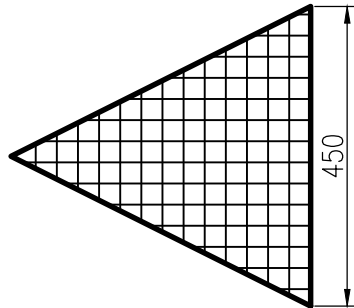

	Nom	Cognom	Data	Num plànol	 <small>Orç [es] [de] [re] [se] [u] [a] [l] [l] [e] [s]</small>
Dibuixat	Laura	Estorch	11/12/2013	1	
Comprovat	Lluís	Corominas			
Escala 1/10	Filtre 10x10 mm				Enginyeria Industrial

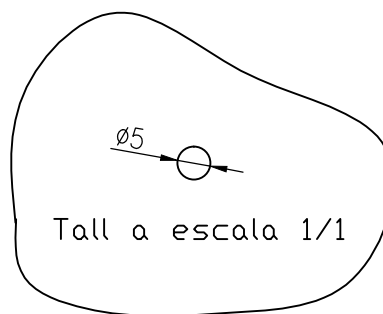
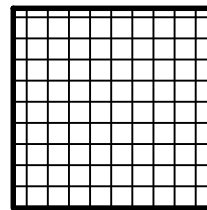
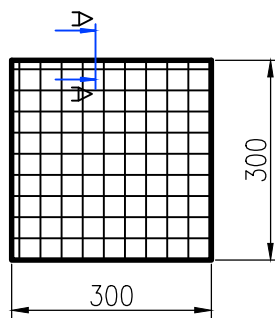
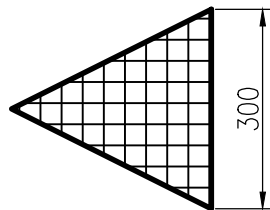

	Nom	Cognom	Data	Num plànol	
Dibuixat	Laura	Estorch	11/12/2013	2	
Comprovat	Lluís	Corominas			
Escala 1/10	Filtre 5x5 mm				Enginyeria Industrial

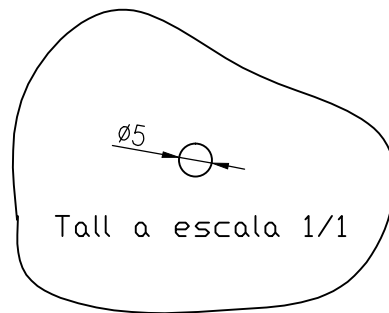
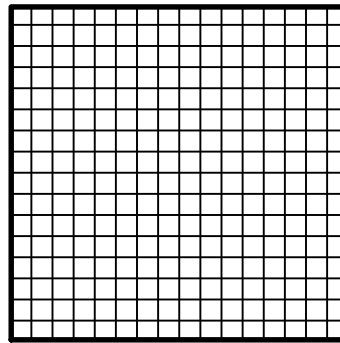
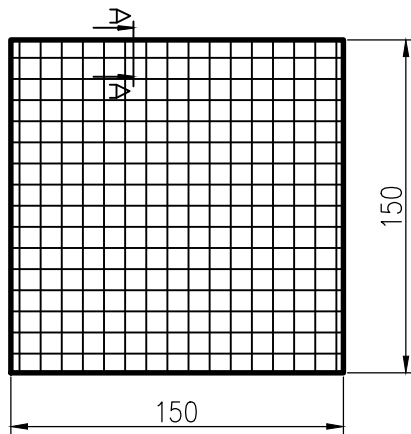
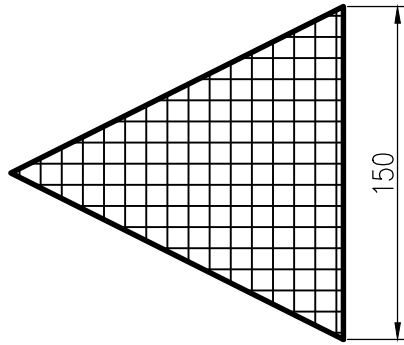

	Nom	Cognom	Data	Num plànol	
Dibuixat	Laura	Estorch	11/12/2013	3	
Comprovat	Lluís	Corominas			
Escala 1/3	Filtre 2x2 mm				Enginyeria Industrial

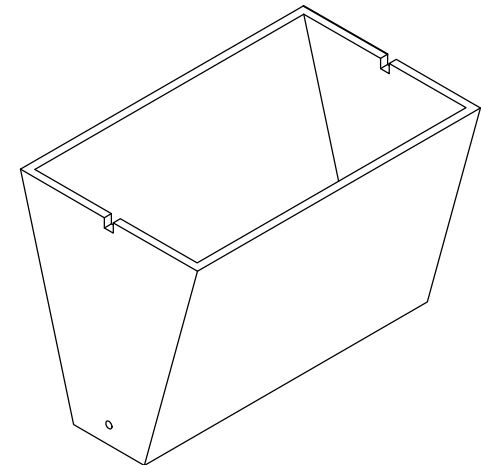
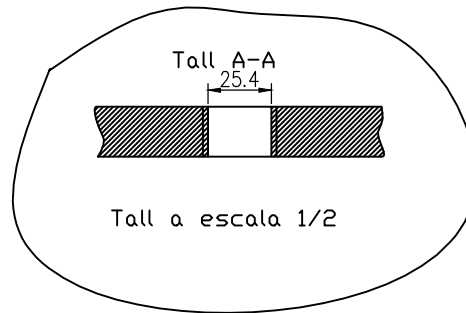
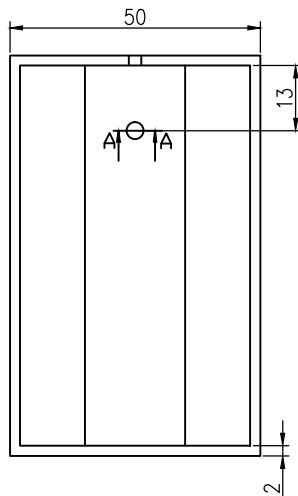
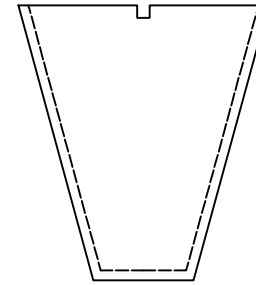
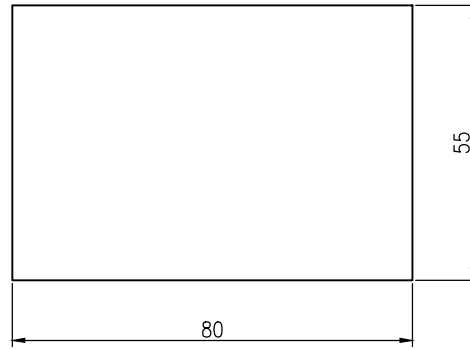
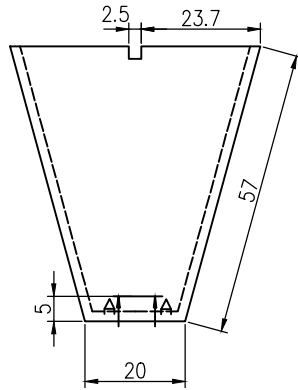

	Data	Nom	Cognom
Dibuixat	04/11/2013	Laura	Estorch
Comprovat	12/11/2013	Lluís	Corominas
Num plànol	4		
Escala:	1/10		
<i>Prototip dipòsit</i>			



UdG Escola Politècnica Superior

Enginyeria Industrial