



**EPS**

Escola Politècnica

**UdG** Superior

## **Projecte/Treball Fi de Carrera**

**Estudi:** Enginyeria Industrial. Pla 1994

**Títol:** Disseny i fabricació del frontal d'un monoplaça de competició en fibra de carboni

**Document:** PLÀNOLS

**Alumne:** Marc Casas Bosch

**Director/Tutor:** Jordi Renart / Josep Vicens

**Departament:** Eng. Mecànica i de la Construcció Industrial

**Àrea:** Enginyeria Mecànica

**Convocatòria** (mes/any): juny / 2007



## PLÀNOLS

Els plànols que formen part d'aquest document són els necessaris per fer un laminat de quatre capes disposats segons el següent esquema:

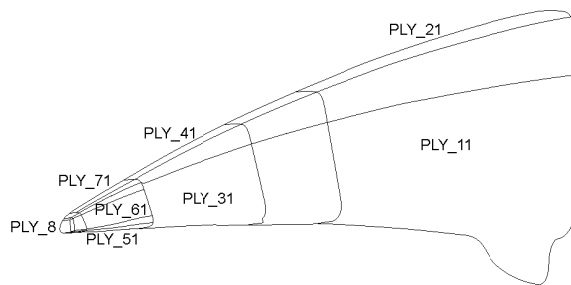

CAPA 1

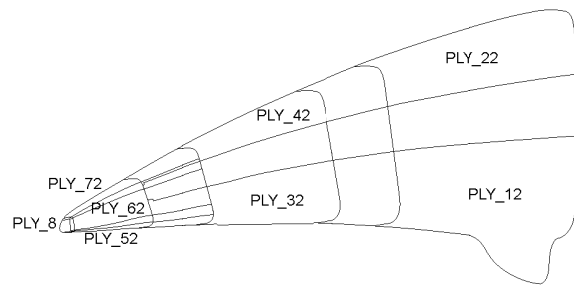

CAPA2

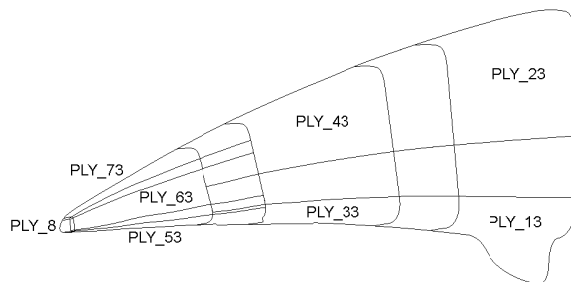

CAPA 3

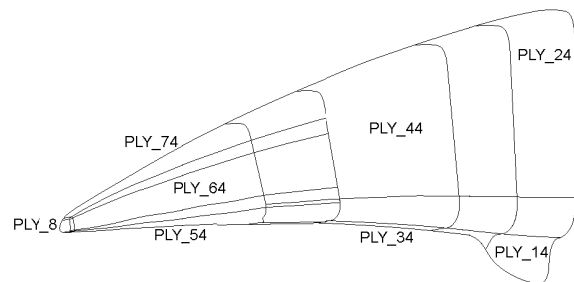

CAPA 4

Per més detall de la disposició dels Plys, consultar el capítol “6. Laminat del model” de la memòria.

S'ha inclòs un plànol de conjunt a escala 1/20 i a continuació els patrons a escala 1/5 amb les cotes totals. Aquestes cotes serveixen per conèixer la quantitat de teixit necessari per cada patró. Per fabricar una peça real es poden plotejar els patrons a escala 1/1, retallar i posteriorment utilitzar com a plantilla per retallar els patrons. Per aquest motiu no s'ha considerat necessari utilitzar més cotes.

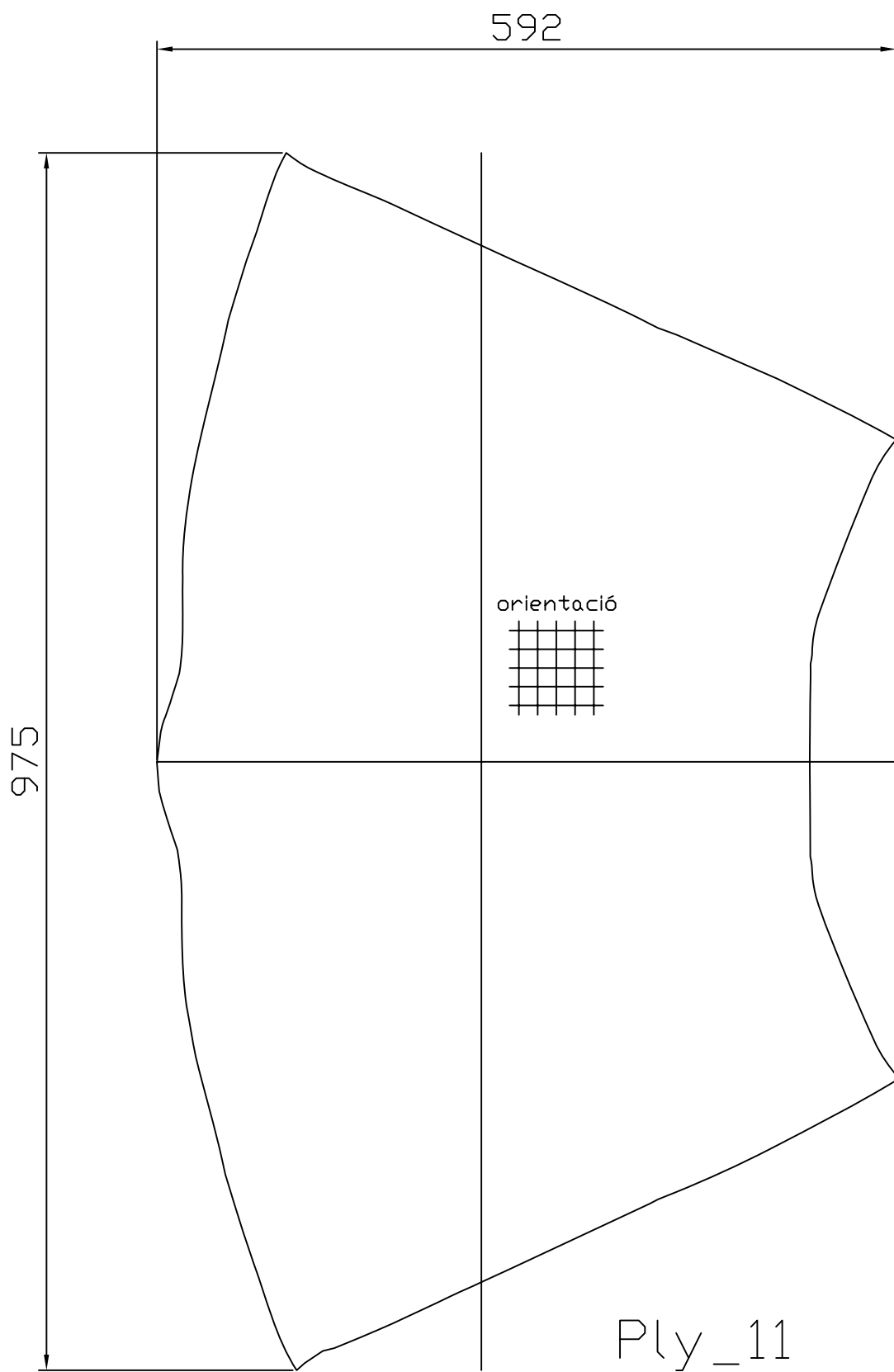

	Data	Nom		 Escola politècnica Superior
Dibuixat	5/6/2007	Marc	Casas	
Compro.		----	----	
Escala	<h1>Capa 1 - 1</h1>			Nº plànol 2
1/5				Substitueix a:
				Especialitat EI

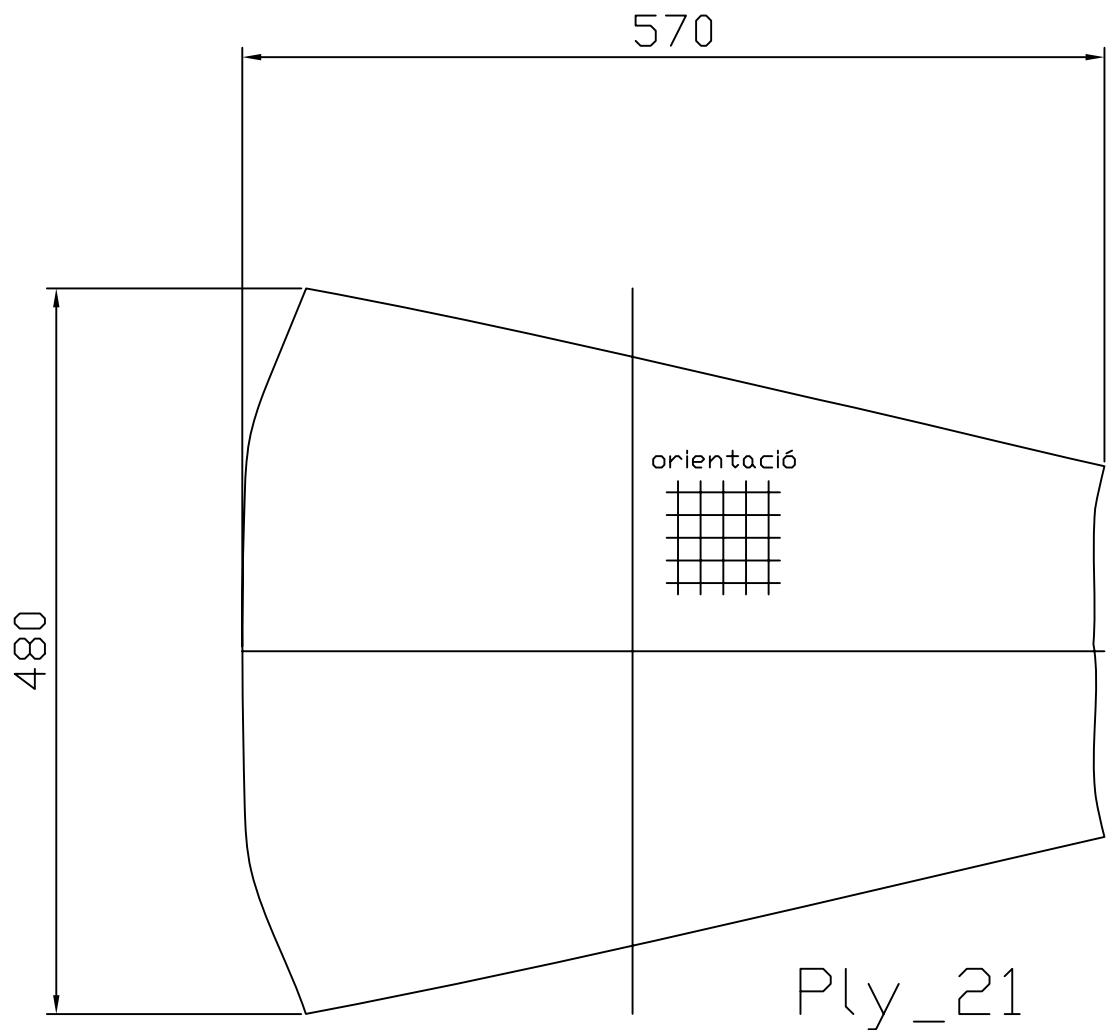

	Data	Nom		 Escola politècnica Superior
Dibuixat	5/6/2007	Marc	Casas	
Compro.		----	----	
Escala <b>1/5</b>	<b>Capa 1 - 2</b>			N° plànol 3 Substitueix a: Especialitat EI

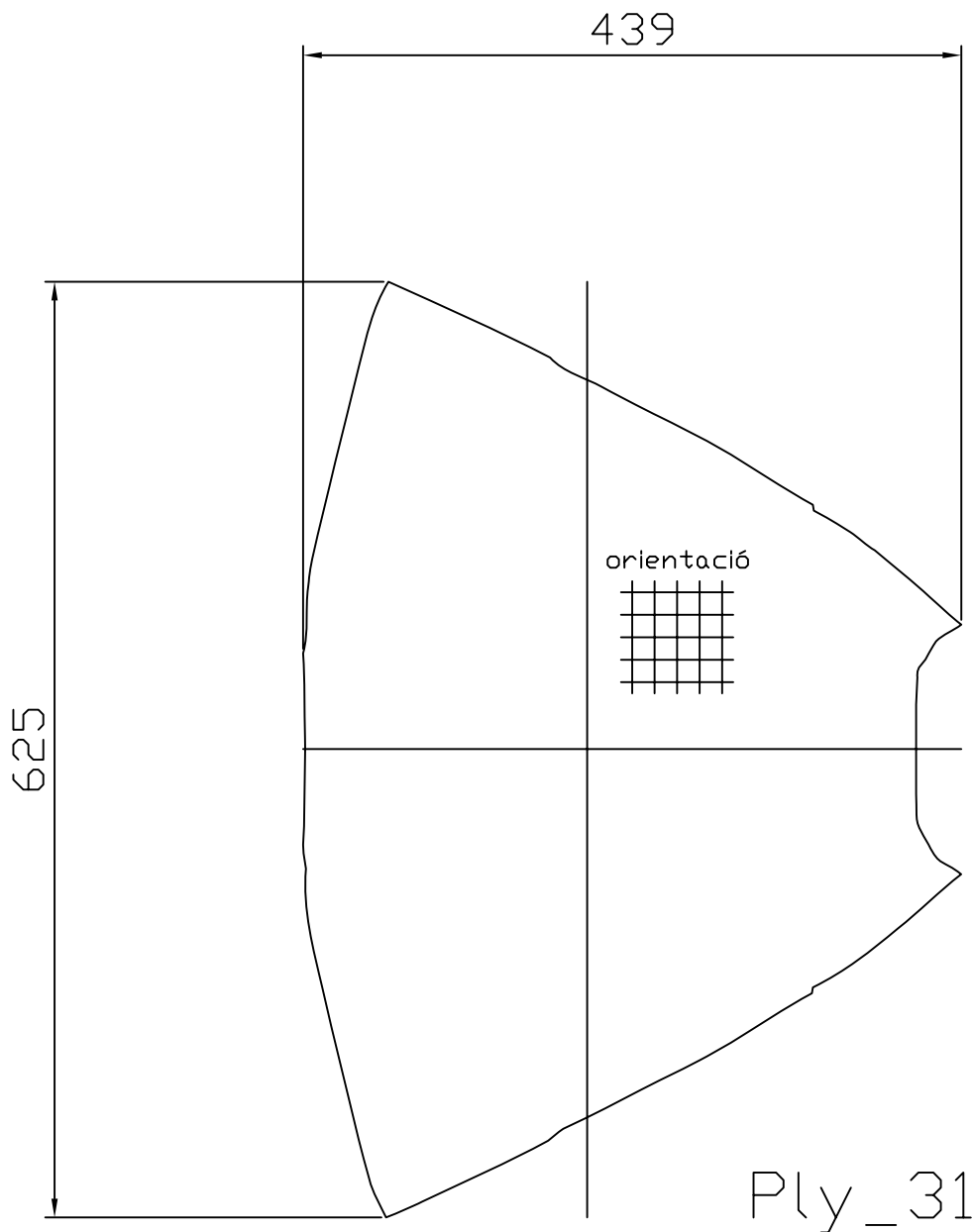

	Data	Nom		 UdG	Escola politècnica Superior
Dibuixat	5/6/2007	Marc	Casas		
Compro.		----	----		
Escala <b>1/5</b>	<b>Capa 1 - 3</b>			N° plànol 4	Substitueix a:
				Especialitat EI	

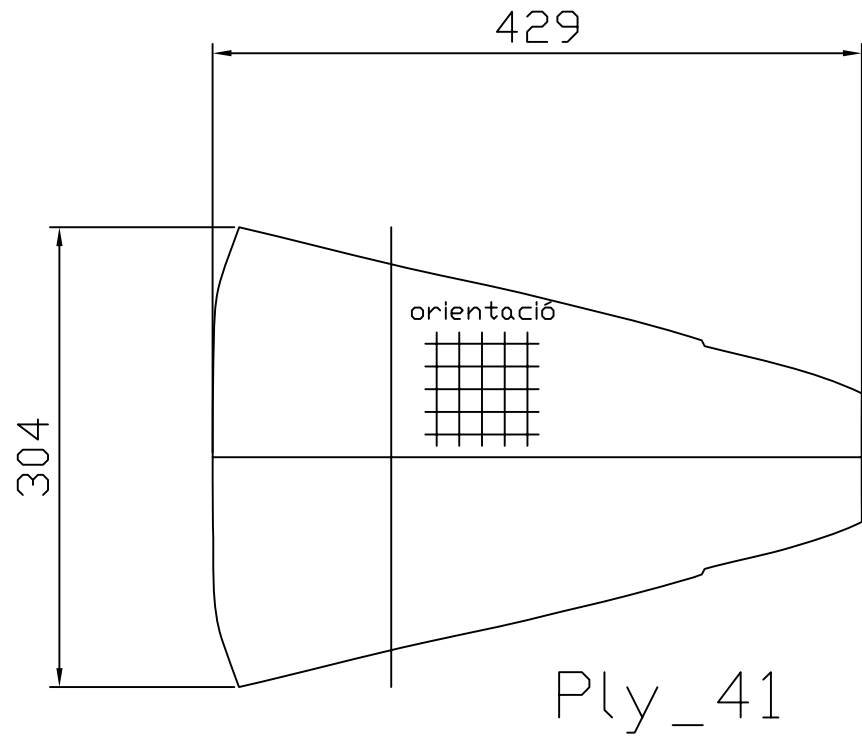

	Data	Nom		 UdG	Escola politècnica Superior
Dibuixat	5/6/2007	Marc	Casas		
Compro.		----	----		
Escala <b>1/5</b>	<b>Capa 1 - 4</b>			N° plànol 5	Substitueix a:
				Especialitat EI	

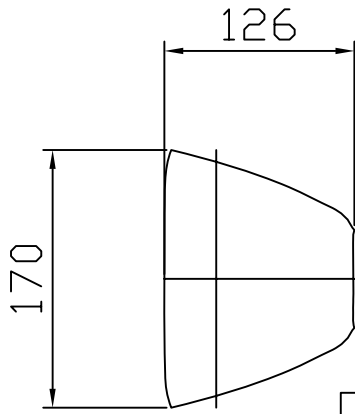

Ply\_51

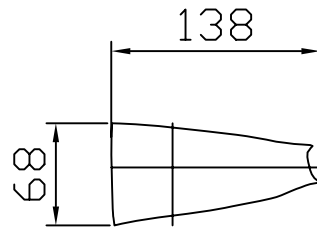
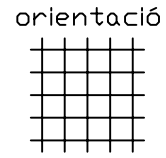

Ply\_61a

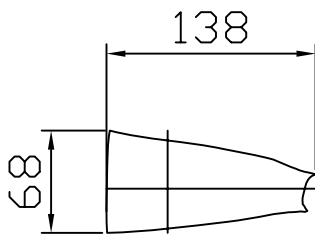

Ply\_61b

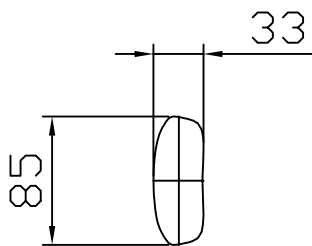

Ply\_8

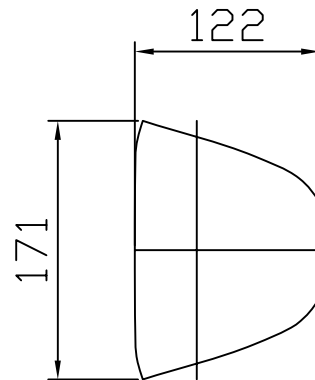

Ply\_71

	Data	Nom		 Escola politècnica Superior
Dibuixat	5/6/2007	Marc	Casas	
Compro.		----	----	
Escala	<h1>Capa 1 - 5</h1>			Nº plànol 6
1/5				Substitueix a:
				Especialitat EI



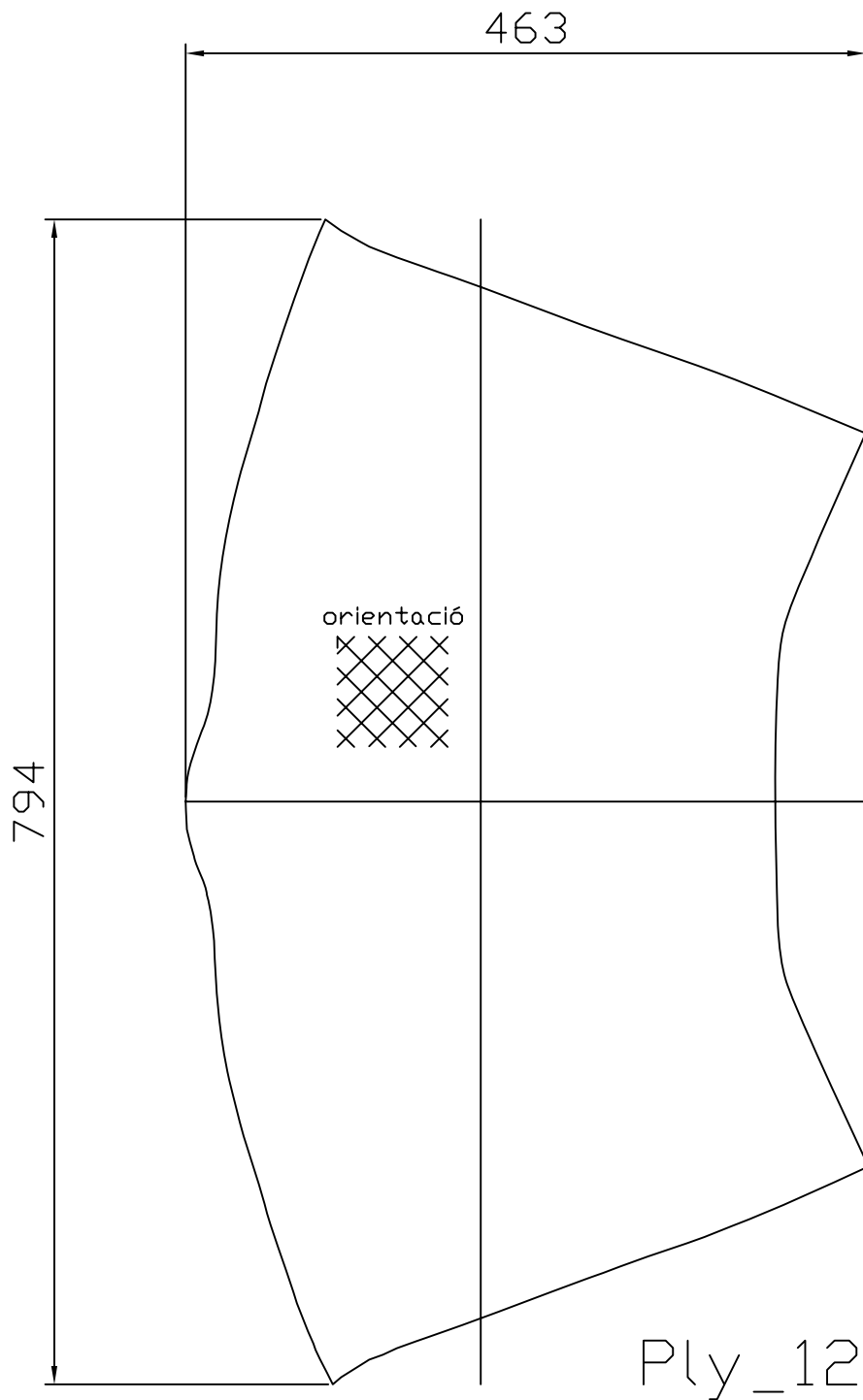

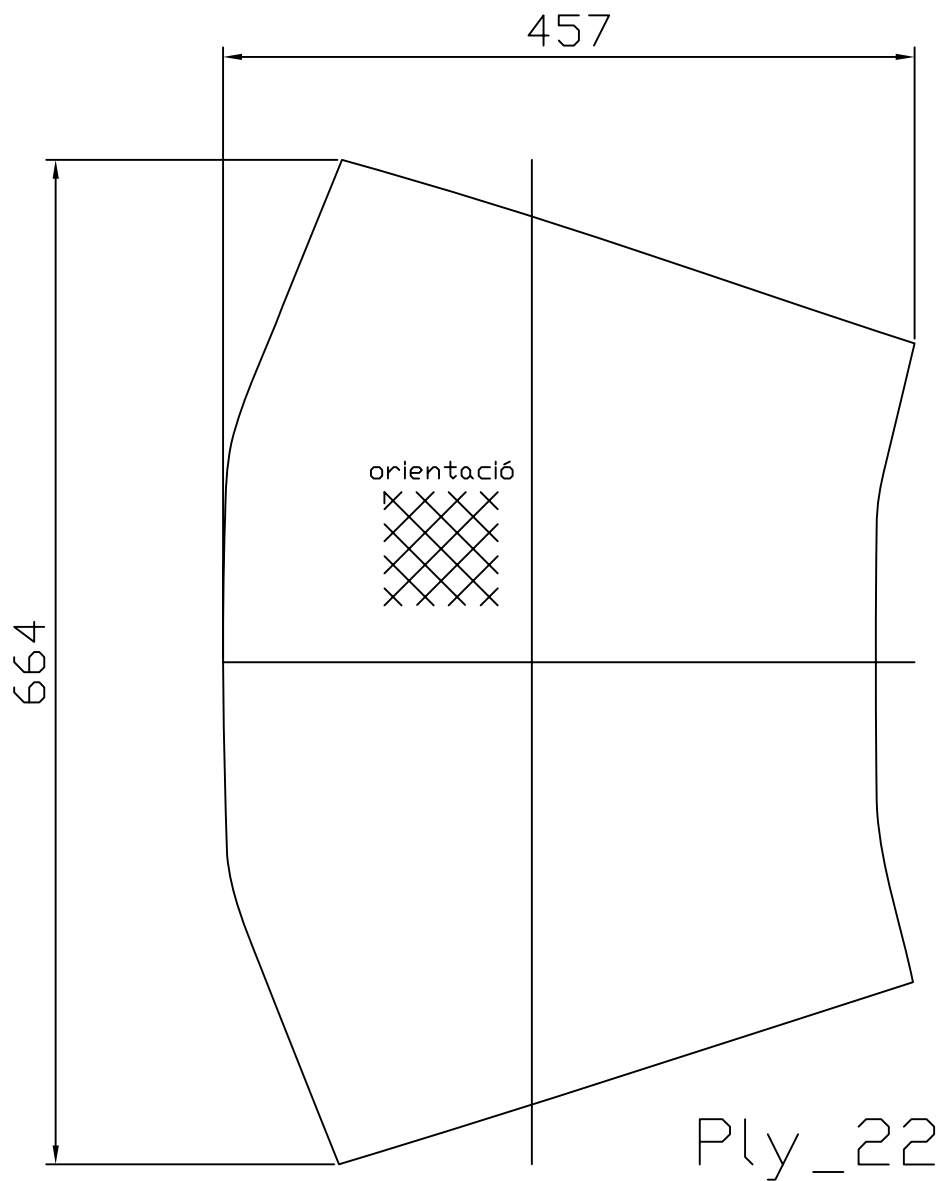

	Data	Nom		 Escola politècnica Superior
Dibuixat	5/6/2007	Marc	Casas	
Compro.		----	----	
Escala <b>1/5</b>	<b>Capa 2 - 1</b>			N° plànol 7 Substitueix a: Especialitat EI

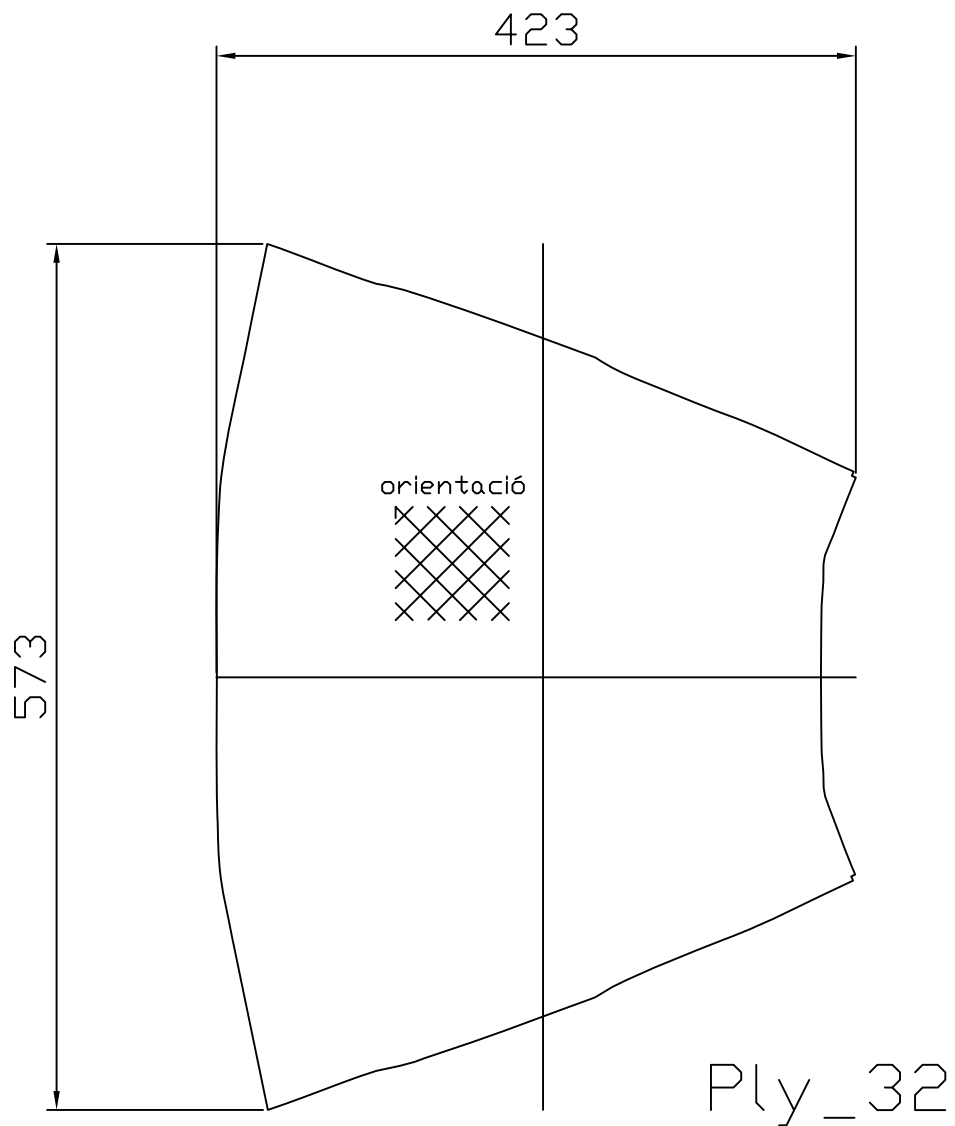

	Data	Nom		 <b>UdG</b>	Escola politècnica Superior
Dibuixat	5/6/2007	Marc	Casas		
Compro.		----	----		
Escala <b>1/5</b>	<b>Capa 2 - 2</b>			Nº plànol 8	
				Substitueix a:	
				Especialitat EI	



	Data	Nom		 <b>UdG</b>	Escola politècnica Superior
Dibuixat	5/6/2007	Marc	Casas		
Compro.		----	----		
Escala <b>1/5</b>	<b>Capa 2 - 3</b>				Nº plànol 9
					Substitueix a:
					Especialitat EI

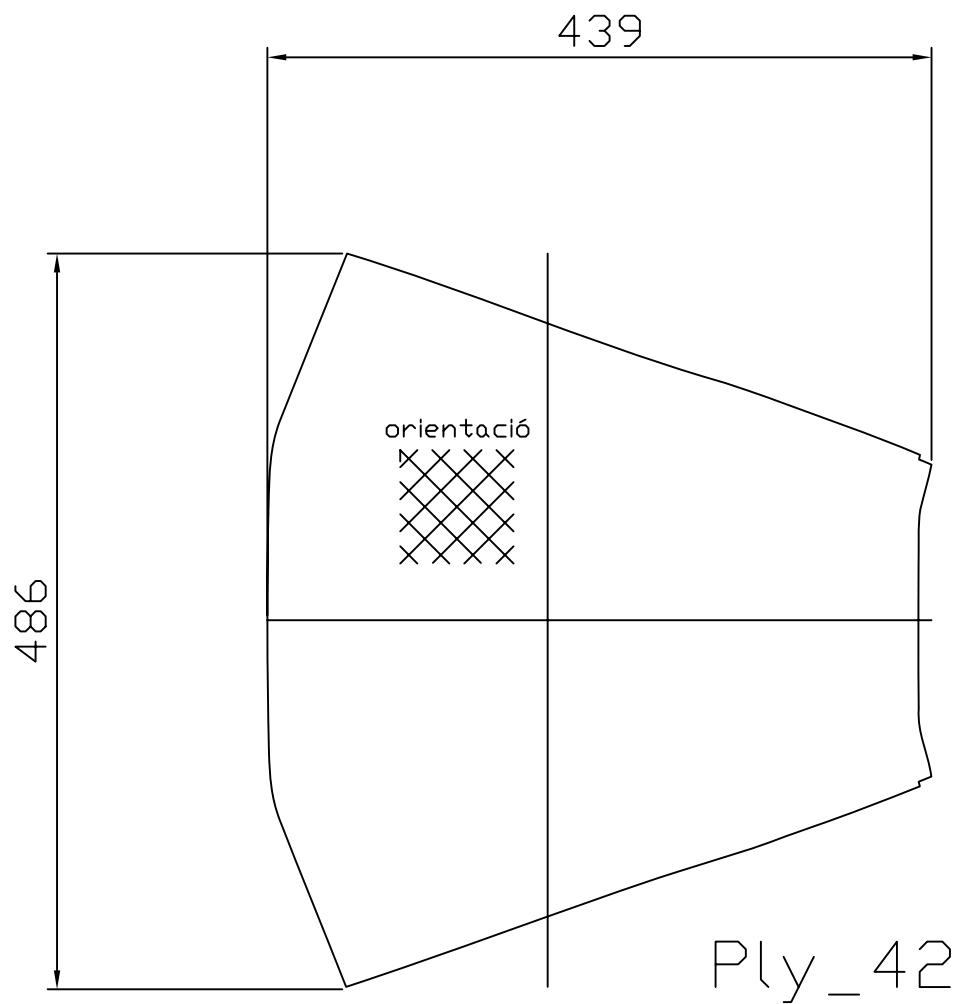

	Data	Nom		 Escola politècnica Superior
Dibuixat	5/6/2007	Marc	Casas	
Compro.		----	----	
Escala	<h1>Capa 2 - 4</h1>			Nº plànol 10
1/5				Substitueix a:
				Especialitat EI

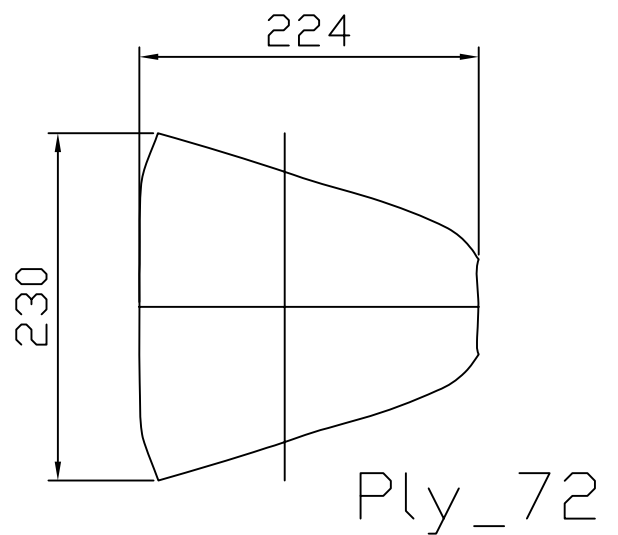
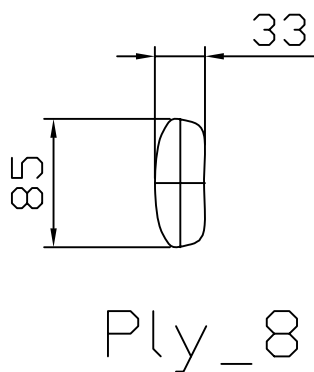
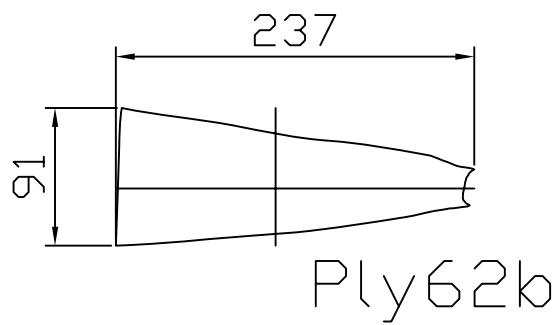
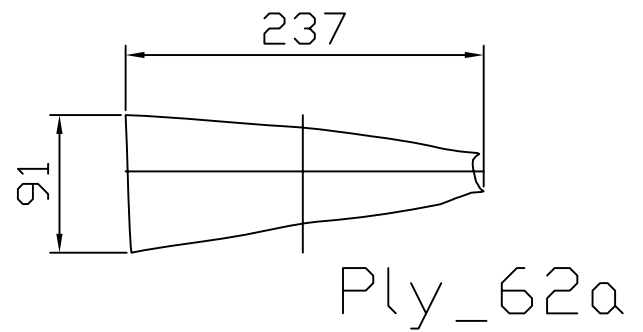
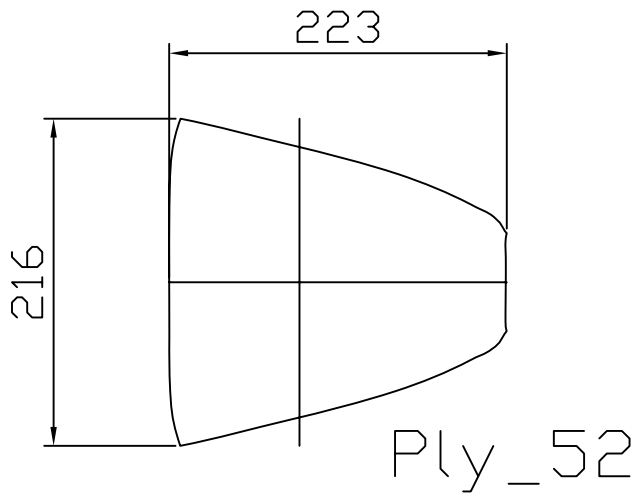

	Data	Nom		 Escola politècnica Superior
Dibuixat	5/6/2007	Marc	Casas	
Compro.		----	----	
Escala	<h1>Capa 2 - 5</h1>			Nº plànol 11
1/5				Substitueix a:
				Especialitat EI

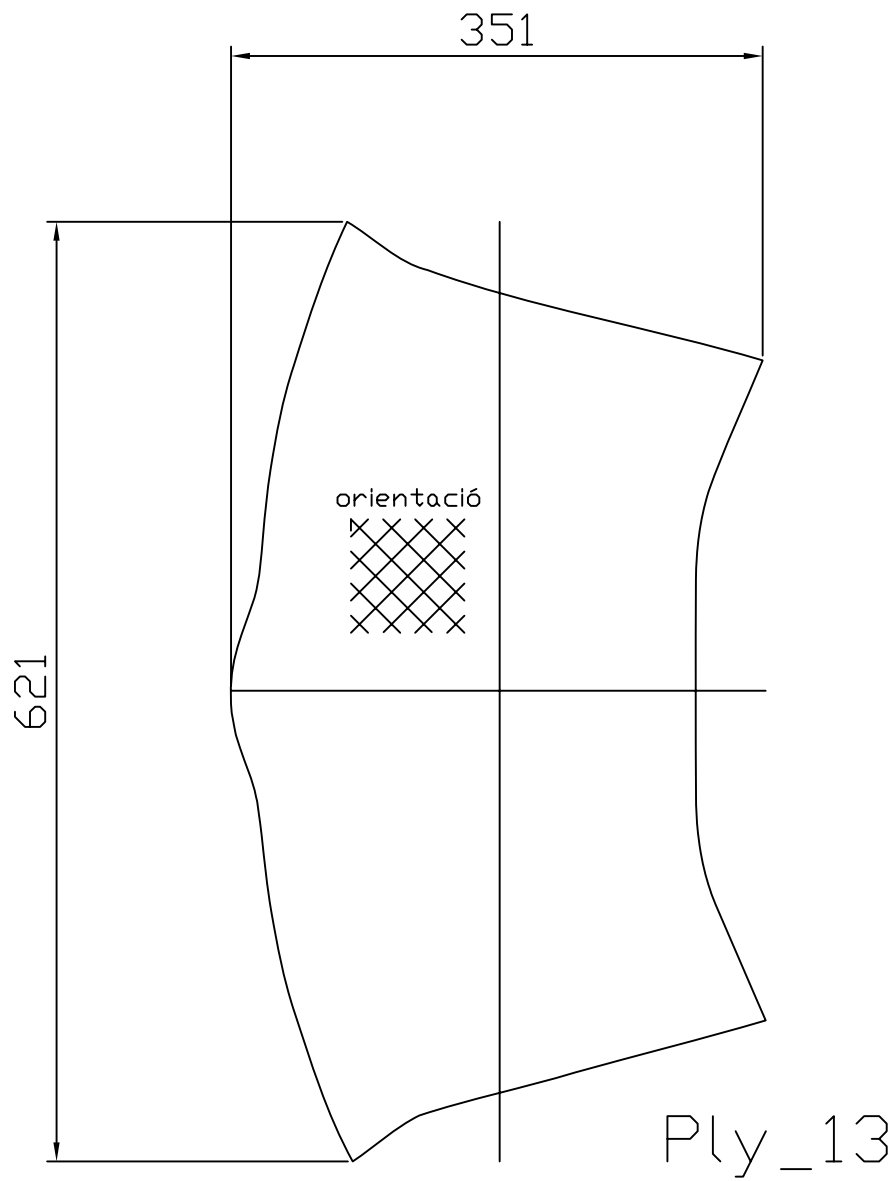

	Data	Nom		 UdG	Escola politècnica Superior
Dibuixat	5/6/2007	Marc	Casas		
Compro.		----	----		
Escala <b>1/5</b>	<b>Capa 3 - 1</b>				N° plànol 12
					Substitueix a:
					Especialitat EI

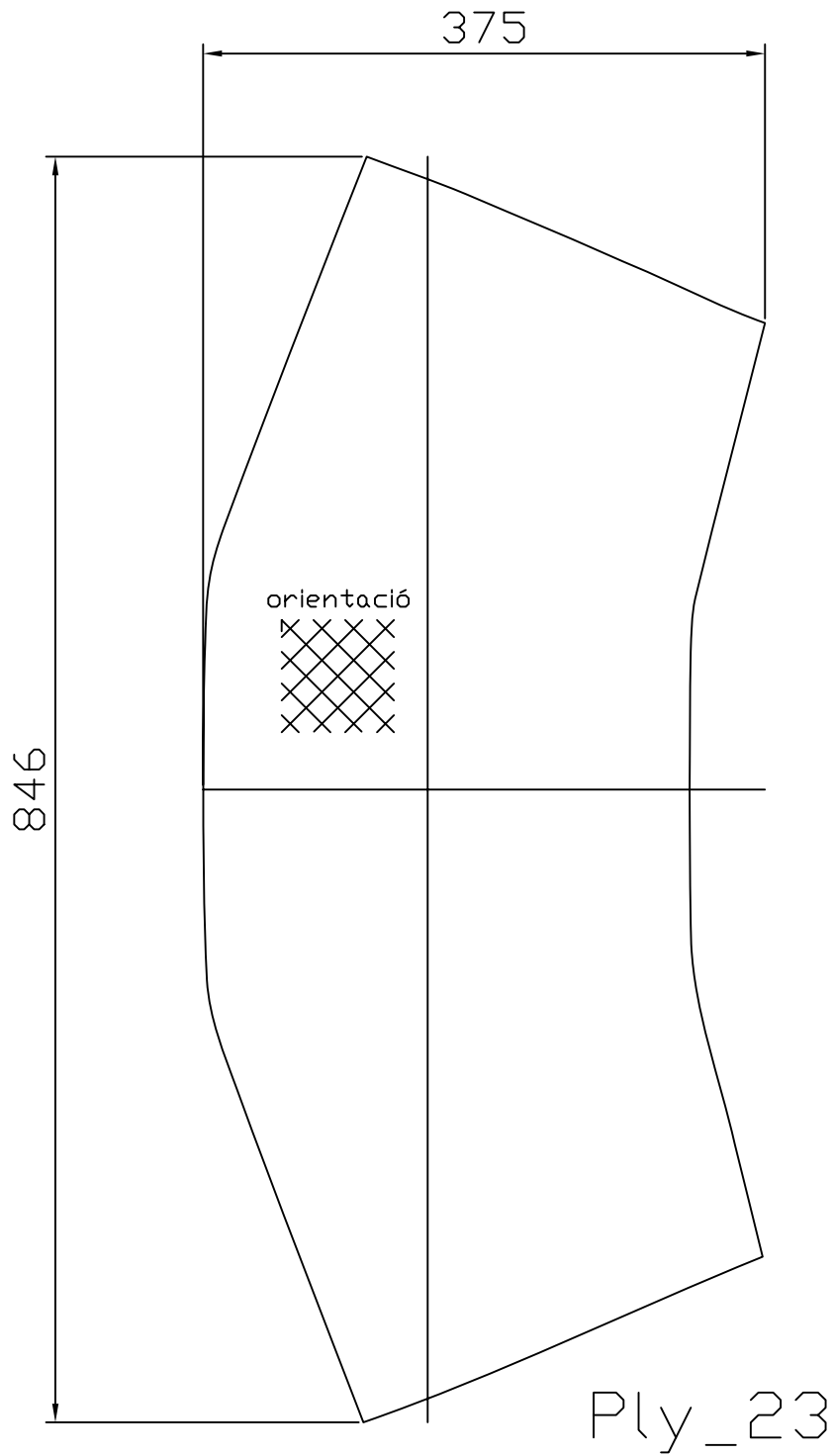

	Data	Nom		 <b>UdG</b>	Escola politècnica Superior
Dibuixat	5/6/2007	Marc	Casas		
Compro.		----	----		
Escala <b>1/5</b>	<b>Capa 3 - 2</b>			N° plànol 13	Substitueix a:
				Especialitat EI	

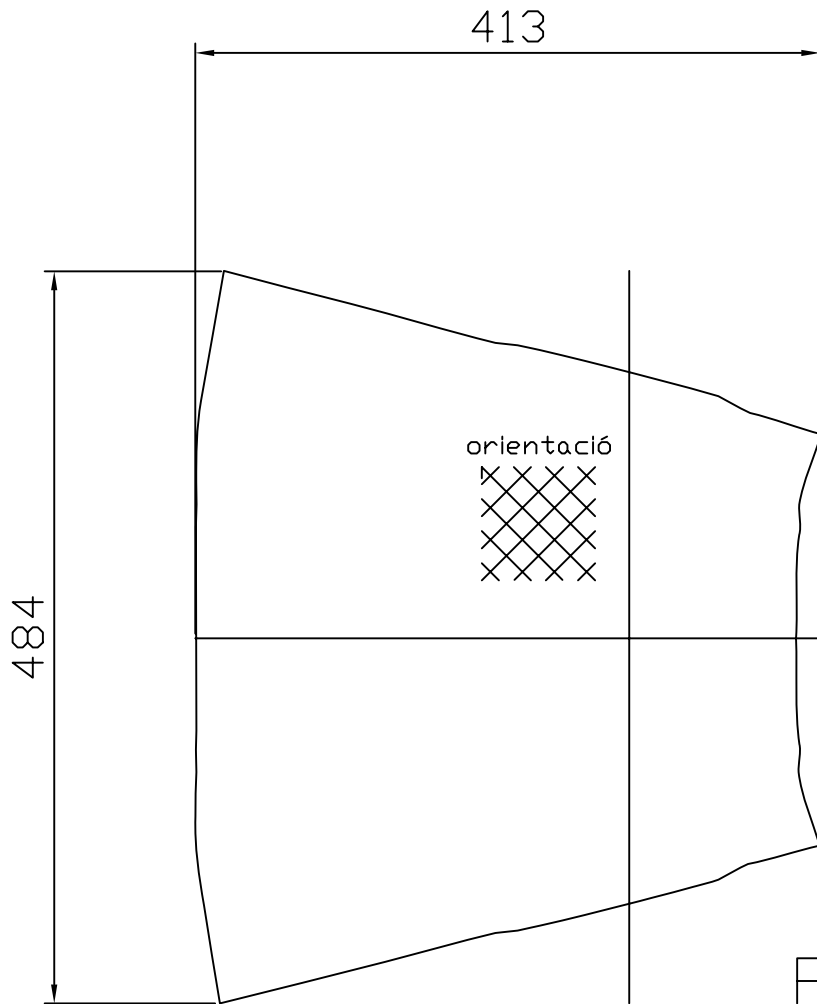

Ply\_33

	Data	Nom		 Escola politècnica Superior
Dibuixat	5/6/2007	Marc	Casas	
Compro.		----	----	
Escala <b>1/5</b>	<b>Capa 3 - 3</b>			N° plànol 14 Substitueix a: Especialitat EI



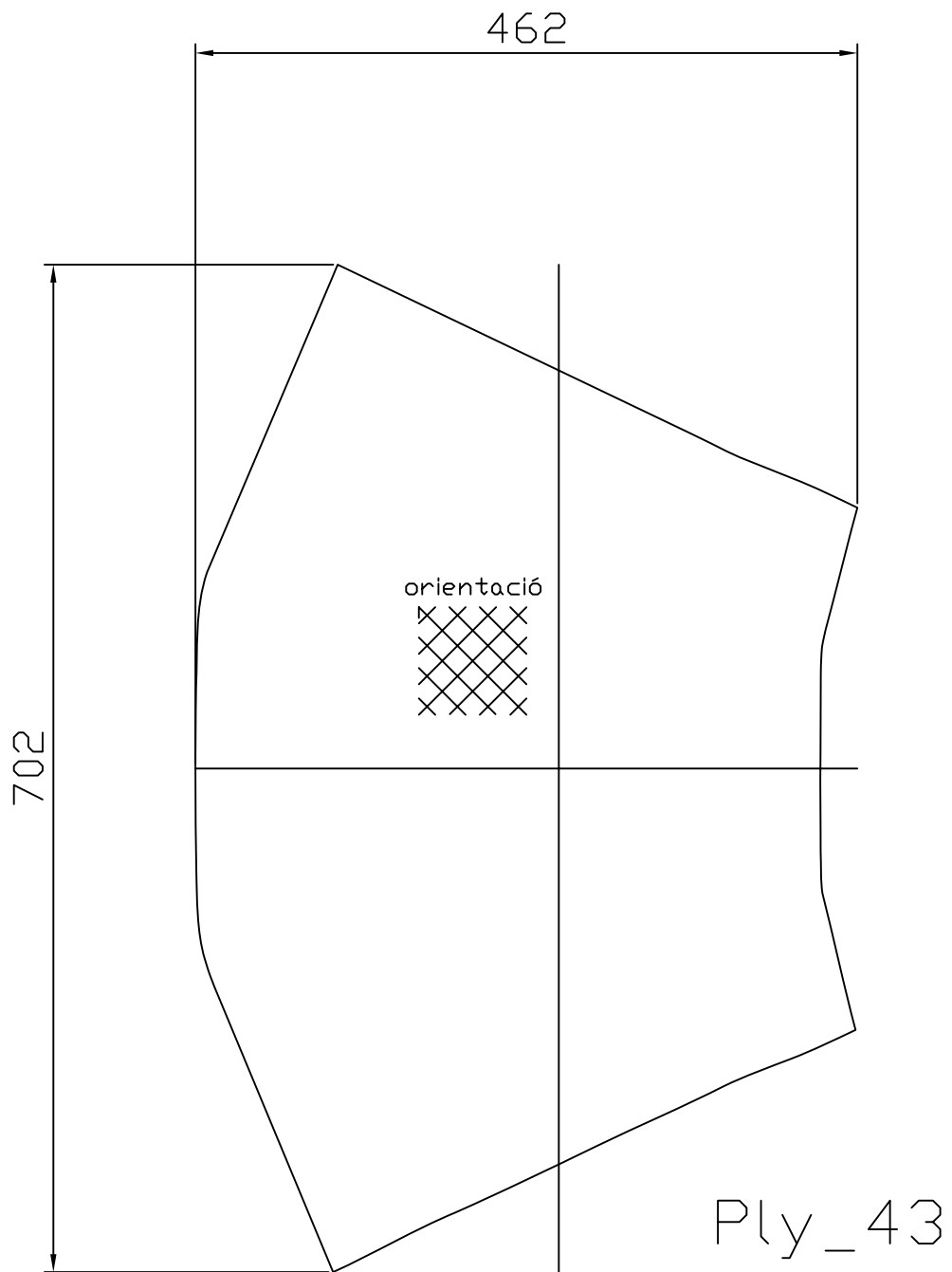

	Data	Nom		 UdG	Escola politècnica Superior
Dibuixat	5/6/2007	Marc	Casas		
Compro.		----	----		
Escala <b>1/5</b>	<b>Capa 3 - 4</b>				N° plànol 15
					Substitueix a:
					Especialitat EI

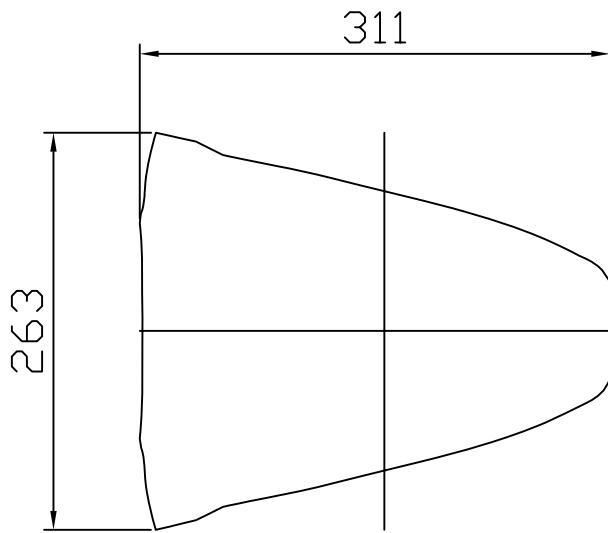

Ply\_53

orientació

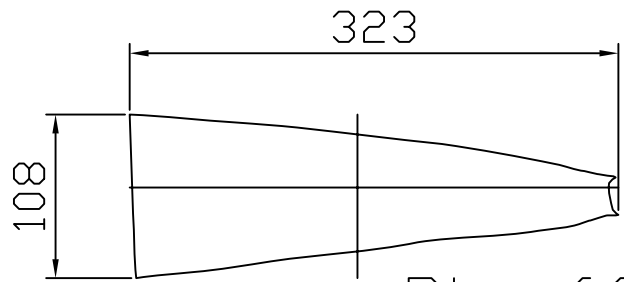
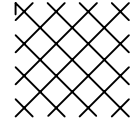

Ply\_63a

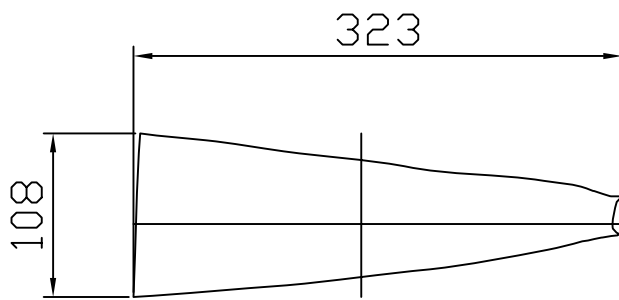

Ply\_63b

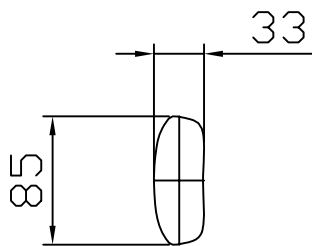

Ply\_8

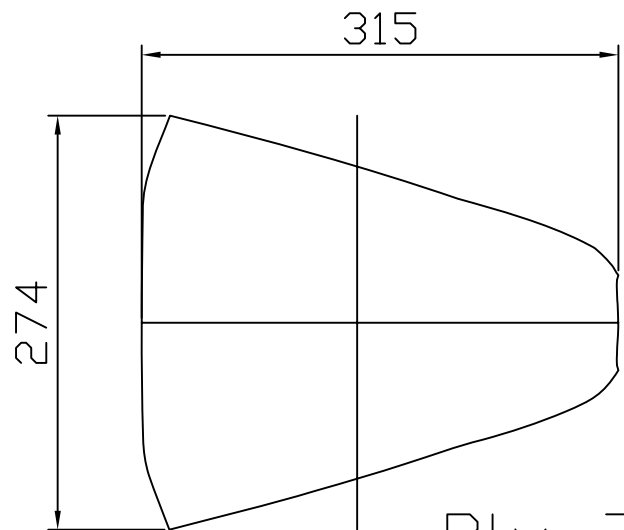

Ply\_73

	Data	Nom	
Dibuixat	5/6/2007	Marc	Casas
Compro.		----	----



UdG

Escola politècnica Superior

Escala  
1/5

Capa 3 - 5

Nº plànol 16

Substitueix a:

Especialitat EI

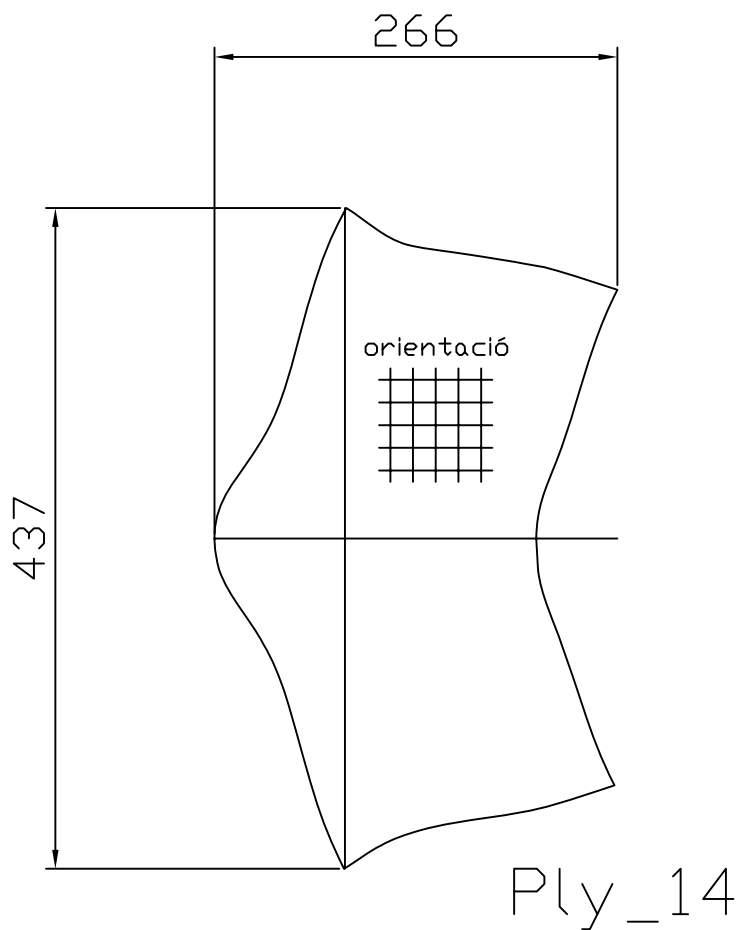

	Data	Nom		 Escola politècnica Superior
Dibuixat	5/6/2007	Marc	Casas	
Compro.		----	----	
Escala <b>1/5</b>	<b>Capa 4 - 1</b>			N° plànol 17 Substitueix a: Especialitat EI

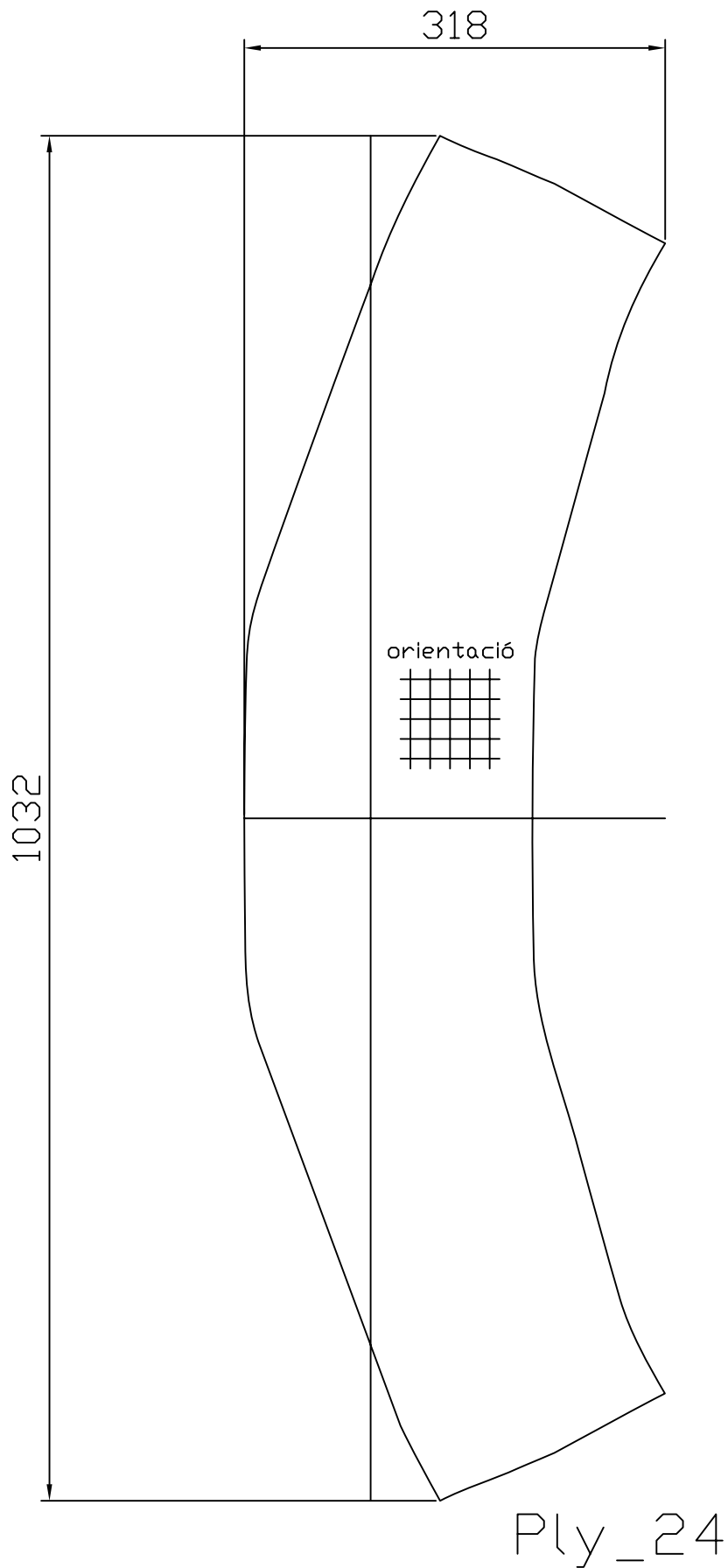

	Data	Nom		 <b>UdG</b>	Escola politècnica Superior
Dibuixat	5/6/2007	Marc	Casas		
Compro.		----	----		
Escala	<h1>Capa 4 - 2</h1>			Nº plànol	18
1/5				Substitueix a:	
				Especialitat	EI

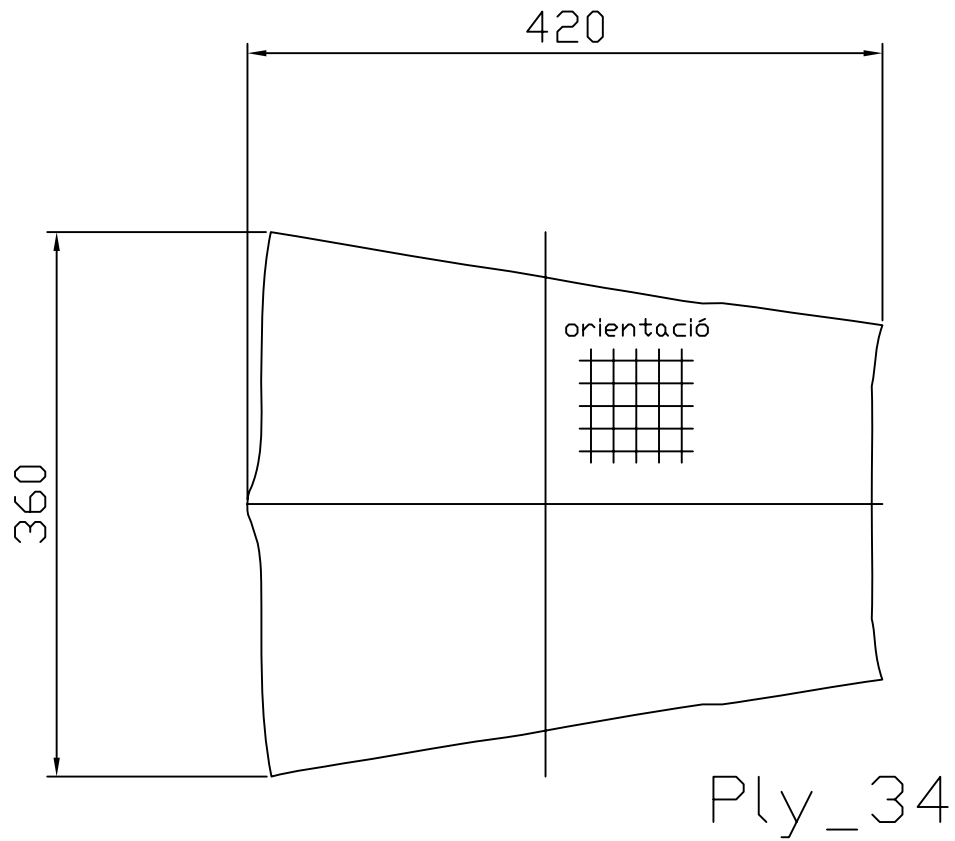

	Data	Nom		 UdG	Escola politècnica Superior
Dibuixat	5/6/2007	Marc	Casas		
Compro.		----	----		
Escala <b>1/5</b>	<b>Capa 4 - 3</b>			N° plànol 19	Substitueix a:
				Especialitat EI	

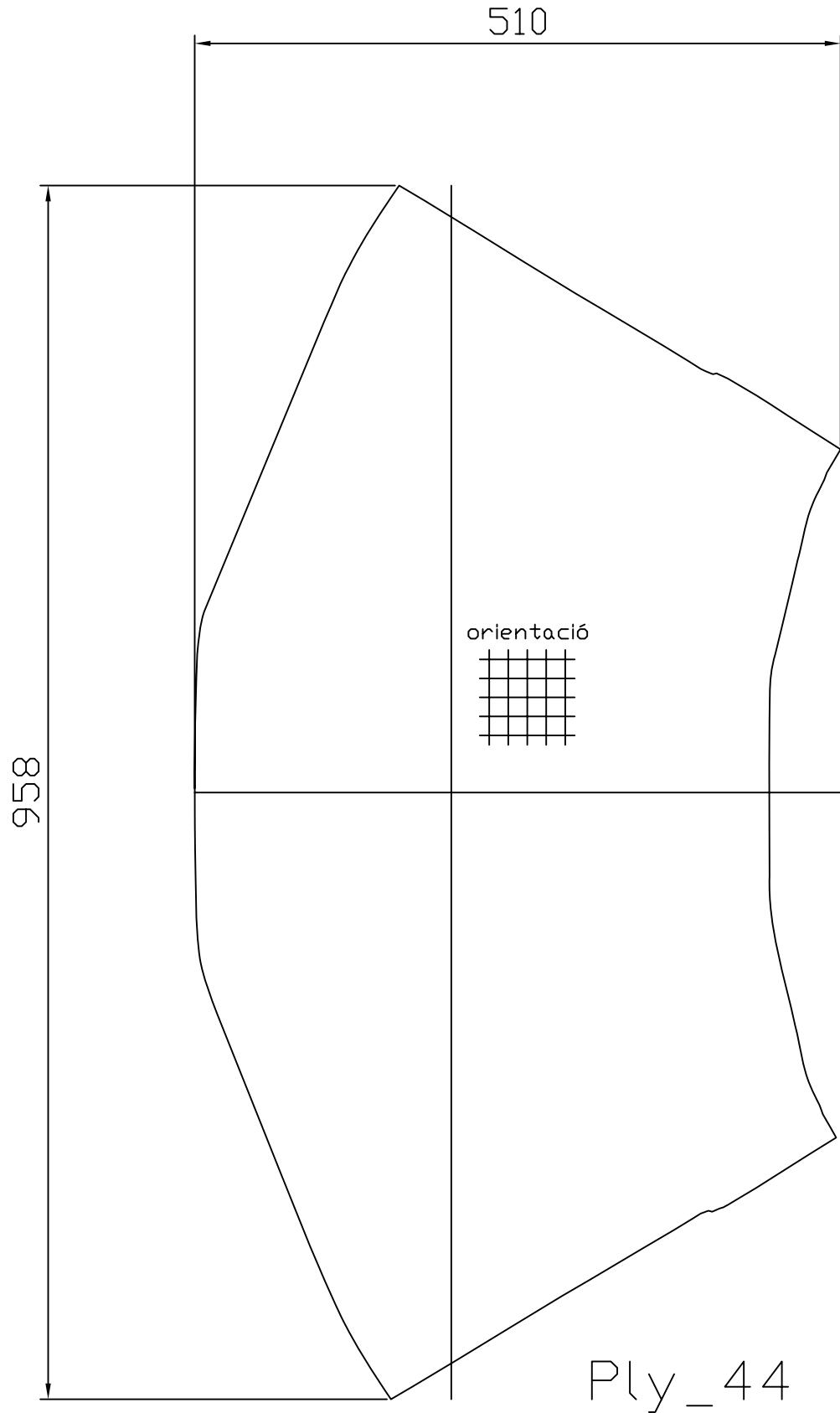

	Data	Nom		 Escola politècnica Superior
Dibuixat	5/6/2007	Marc	Casas	
Compro.		----	----	
Escala	<h1>Capa 4 - 4</h1>			Nº plànol 20
1/5				Substitueix a:
				Especialitat EI

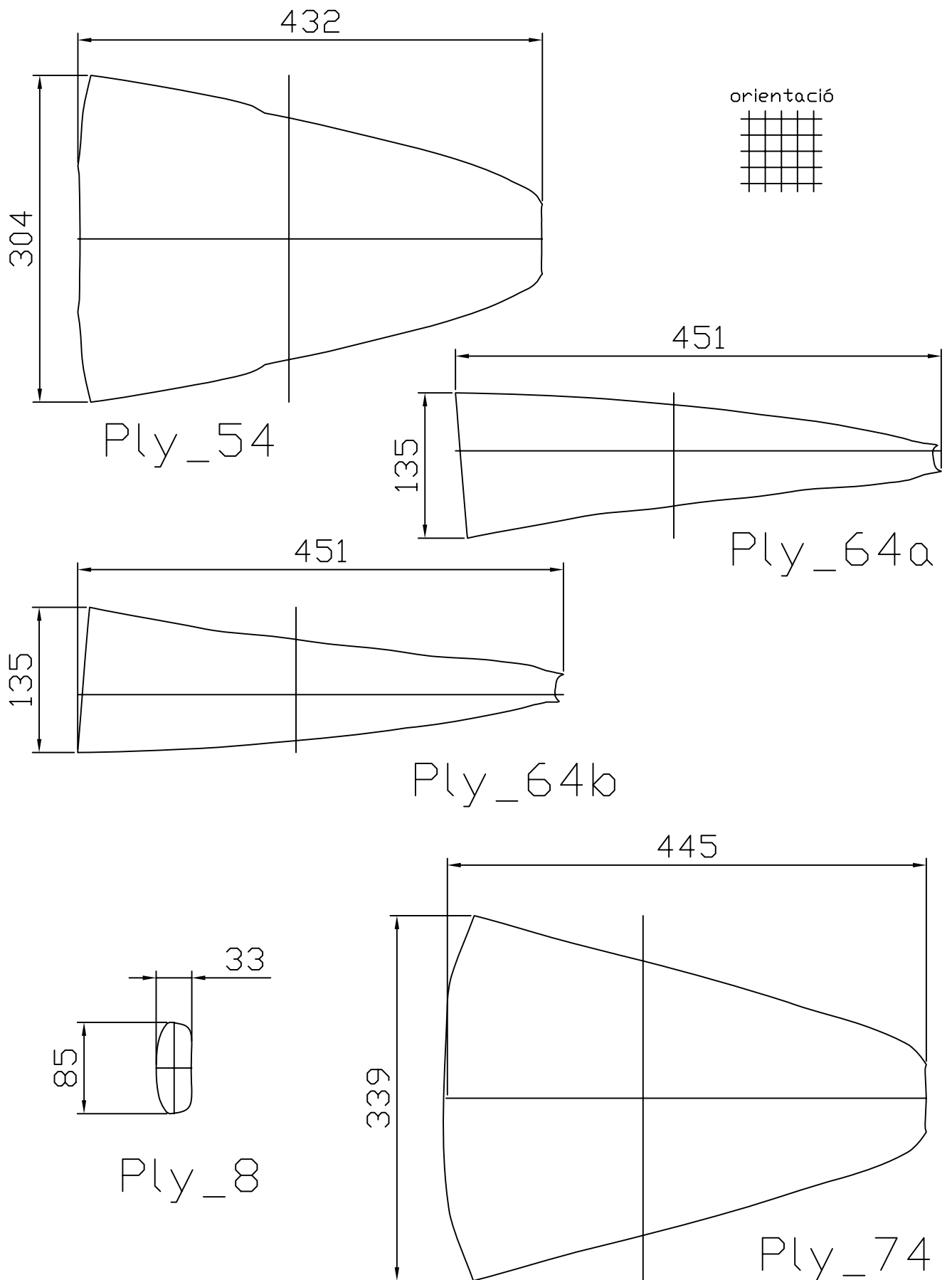

	Data	Nom		 Escola politècnica Superior
Dibuixat	5/6/2007	Marc	Casas	
Compro.		----	----	
Escala	<h1>Capa 4 - 5</h1>			Nº plànol 21
1/5				Substitueix a:
				Especialitat EI

CAPA 1

CAPA 2

CAPA 3

CAPA 4

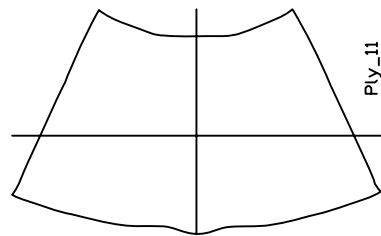

Ply\_11

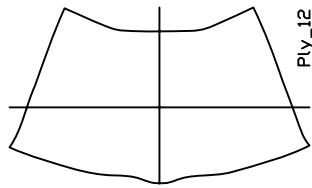

Ply\_12

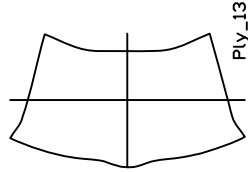

Ply\_13

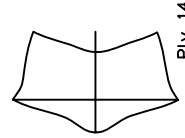

Ply\_14

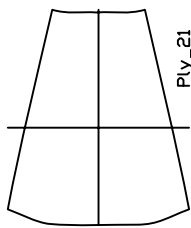

Ply\_21

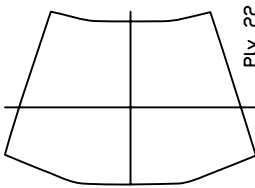

Ply\_22

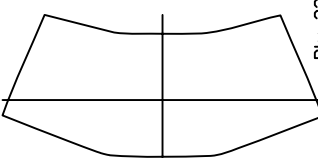

Ply\_23

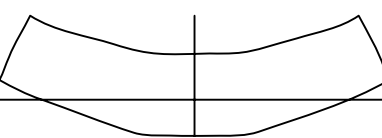

Ply\_24

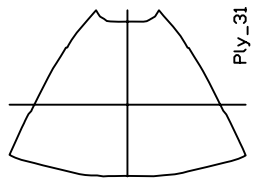

Ply\_31

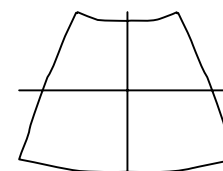

Ply\_32

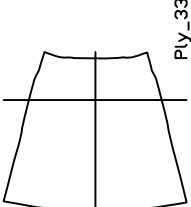

Ply\_33

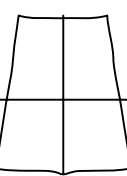

Ply\_34

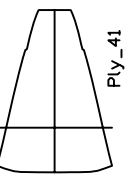

Ply\_41

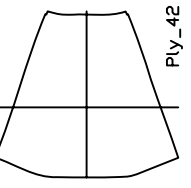

Ply\_42

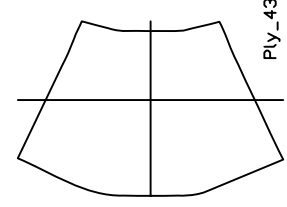

Ply\_43

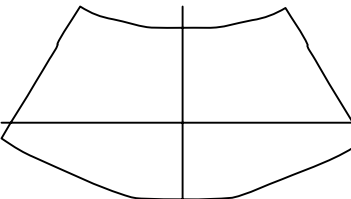

Ply\_44



Ply\_51

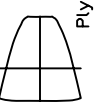

Ply\_52

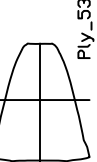

Ply\_53

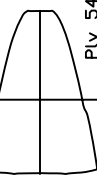

Ply\_54

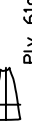

Ply\_61a



Ply\_62a



Ply\_63a

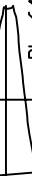

Ply\_64a

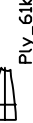

Ply\_61b



Ply\_62b



Ply\_63b



Ply\_64b

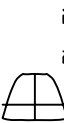

Ply\_71



Ply\_72

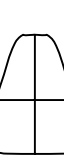

Ply\_73

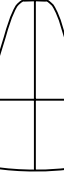

Ply\_74

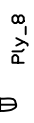

Ply\_8



Ply\_8



Ply\_8

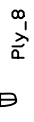

Ply\_8

	Data	Nom	
Dibuixat	5/6/2007	Marc	Casas
Compro.		---	---



Escola politècnica Superior

Escala  
1/20

Conjunt de patrons

Nº plànol 1

Substitueix a:

Especialitat EI