



Universitat de Girona  
Escola Politècnica Superior

## Projecte/Treball Final de Carrera

**Estudi:** Enginyeria Tècn. Ind. Electrònica Ind. Pla 2002

**Títol:**

Sistema de manteniment de l'equilibri  
per a un robot bípede

**Document:** 2. PLÀNOLS

**Alumne:** Pere Amadó Codony

**Director/Tutor:** Marc Carreras i Pérez / Lluís Magí i Carceller

**Departament:** Electrònica, Informàtica i Automàtica

**Àrea:** Arquitectura i Tecnologia de Computadors

**Convocatòria** (mes/any): Gener 2006

## **ÍNDEX**

Plànol 1: ROBOT BÍPEDE

Plànol 2: MOTOR-REDUCTOR-ENCODER

Plànol 3: GUIA I PATÍ

Plànol 4: ESQUEMA ELÈCTRIC PLACA

Plànol 5: CAPA TOP PLACA

Plànol 6: CAPA BOTTOM PLACA

Plànol 7: DISPOSICIÓ COMPONENTS

### A. ANNEX

Plànol A1: CUIXA

Plànol A2: TÍBIA-PERONÉ

Plànol A3: PEU

Plànol A4: ACTUADOR LINEAL

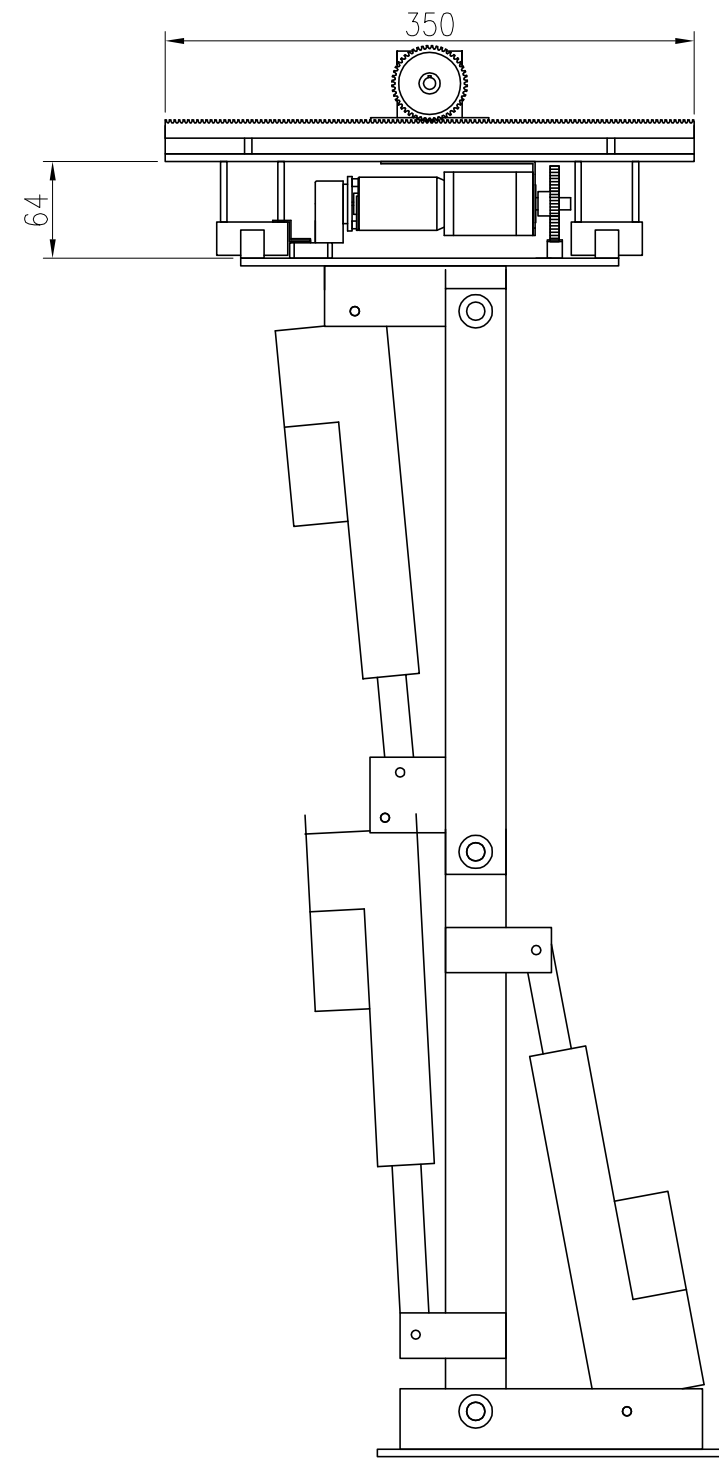
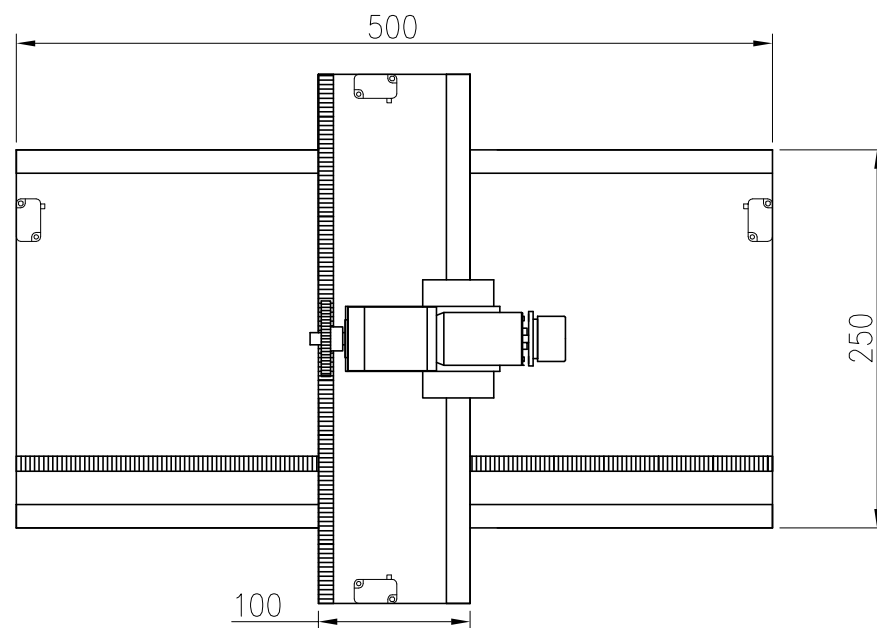
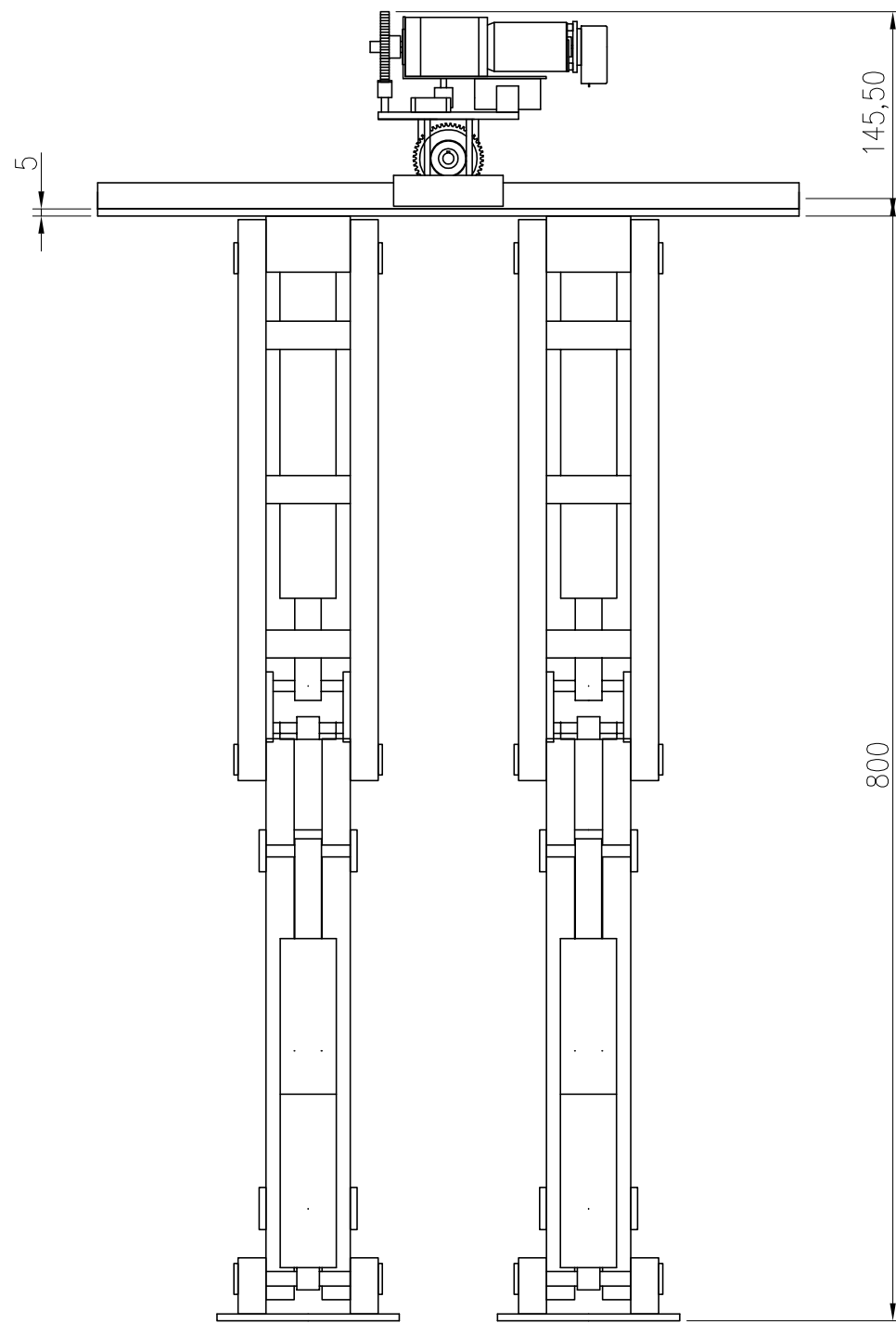

	Data	Nom	Signatura	 Escola politècnica Superior
Dibuixat	15-05-05	Pere Amadó		
Compro.	20-05-05	Pere Amadó		
Escala <b>1/5</b>	<b>ROBOT BÍPEDE</b>			Nº plànol 1 Substitueix a: Especialitat ETIEI

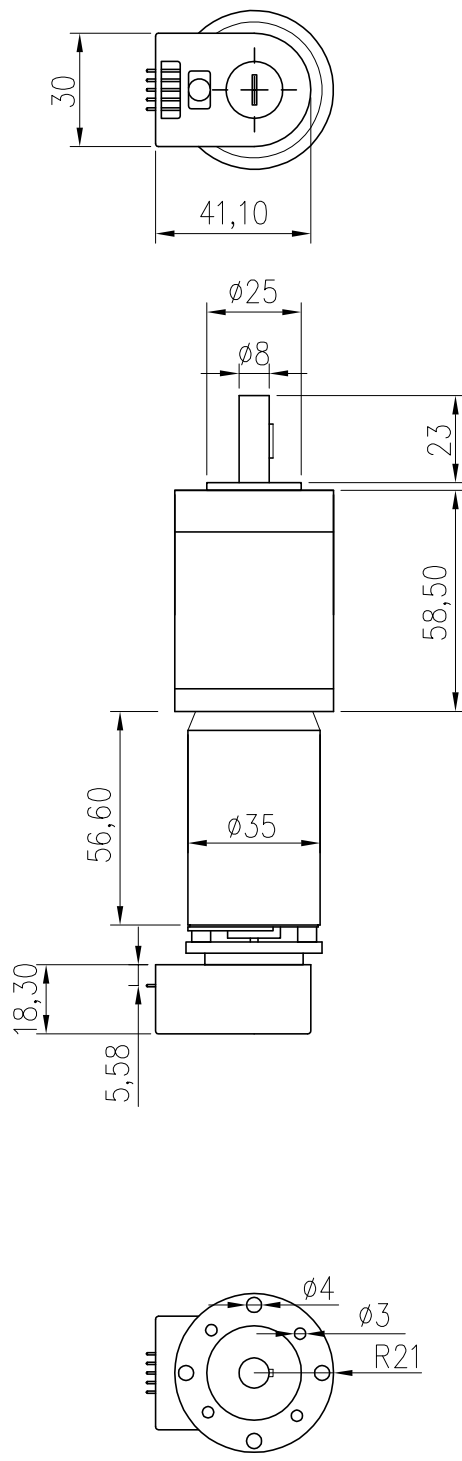

	Data	Nom	Signatura	 Escola politècnica Superior
Dibuixat	26-12-05	Pere Amadó		
Compro.	31-12-05	Pere Amadó		
Escala <b>1/2</b>	<b>MOTOR-REDUCTOR-ENCODER</b>			Nº plànol 2 Substitueix a: Especialitat ETIEI

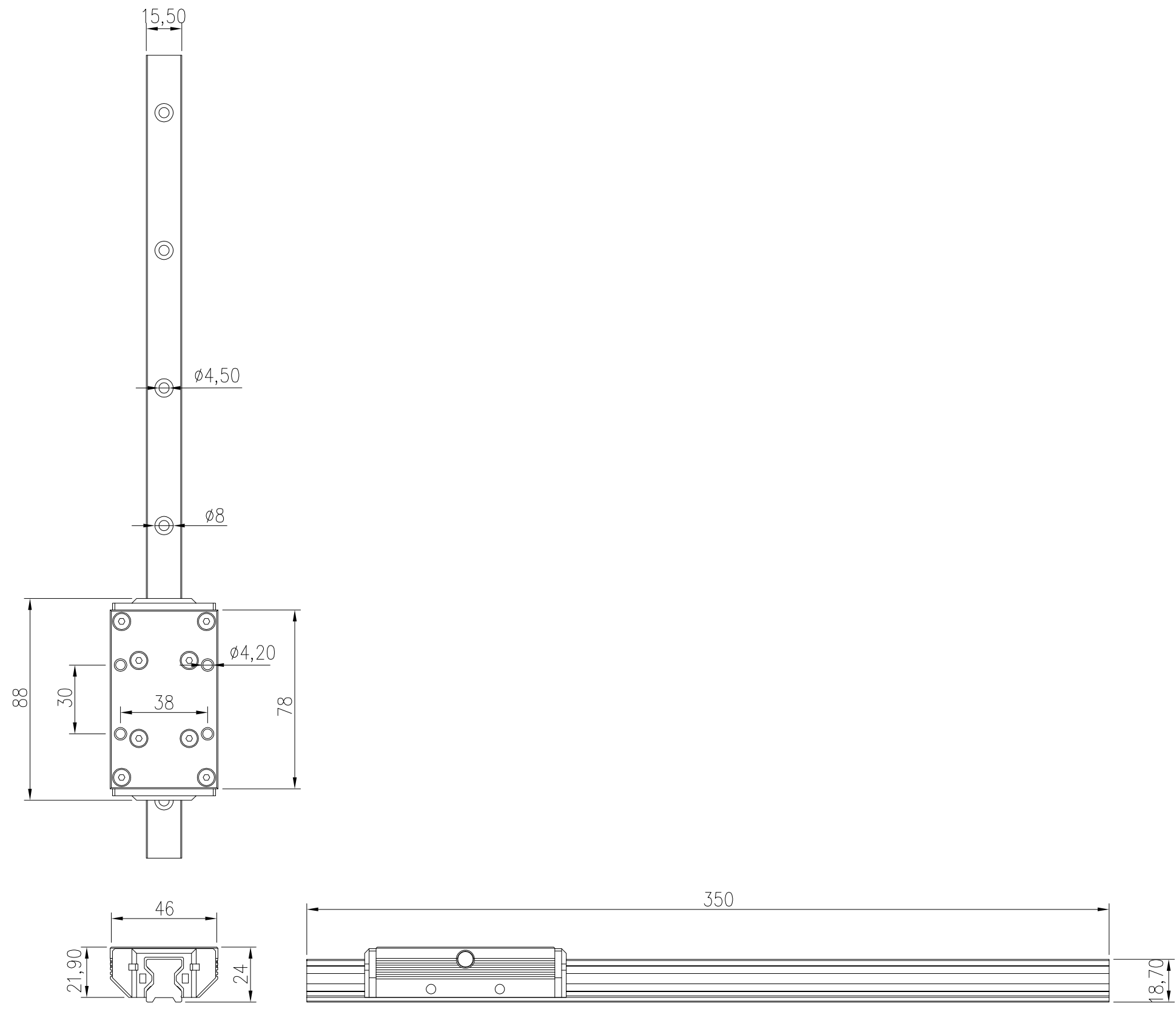

	Data	Nom	Signatura	 Escola politècnica Superior
Dibuixat	23-10-05	Pere Amadó		
Compro.	26-12-05	Pere Amadó		
Escala <b>1/2</b>	<b>GUIA I PATÍ</b>			N° plànol 3 Substitueix a: Especialitat ETIEI

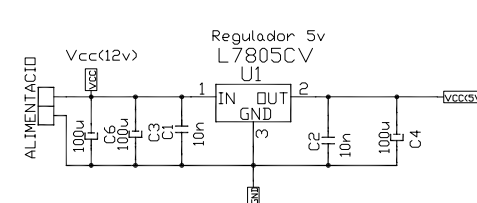
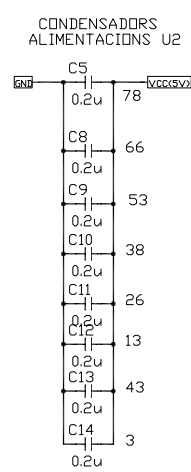
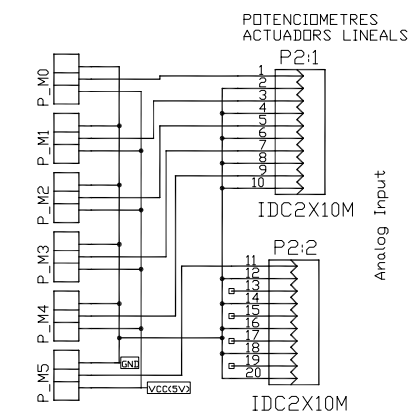
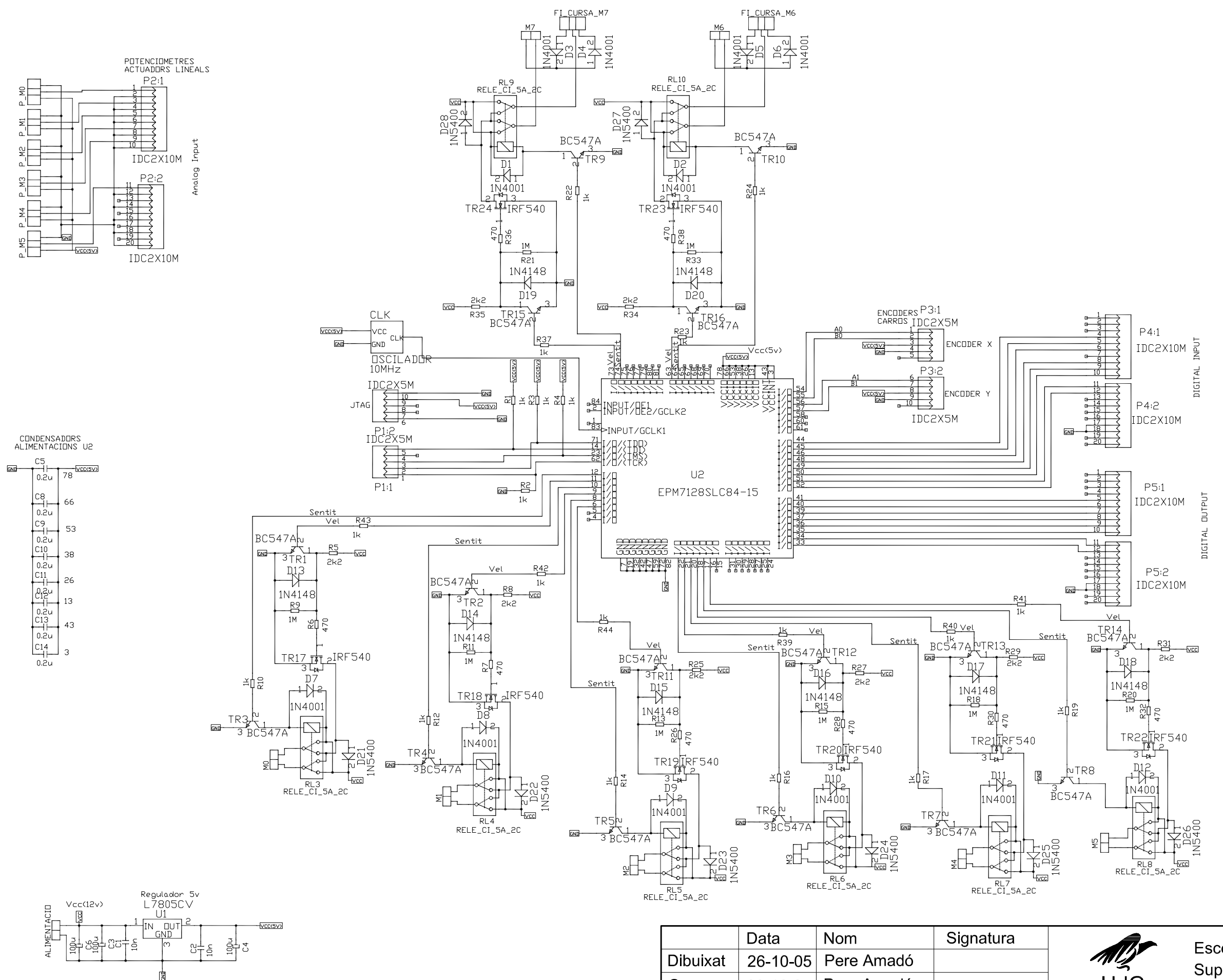

	Data	Nom	Signatura	 Escola politècnica Superior
Dibuixat	26-10-05	Pere Amadó		
Compro.	22-12-05	Pere Amadó		
Escala <b>S.E.</b>	<b>ESQUEMA ELÈCTRIC PLACA</b>			Nº plànol 4 Substitueix a: Especialitat ETIEI

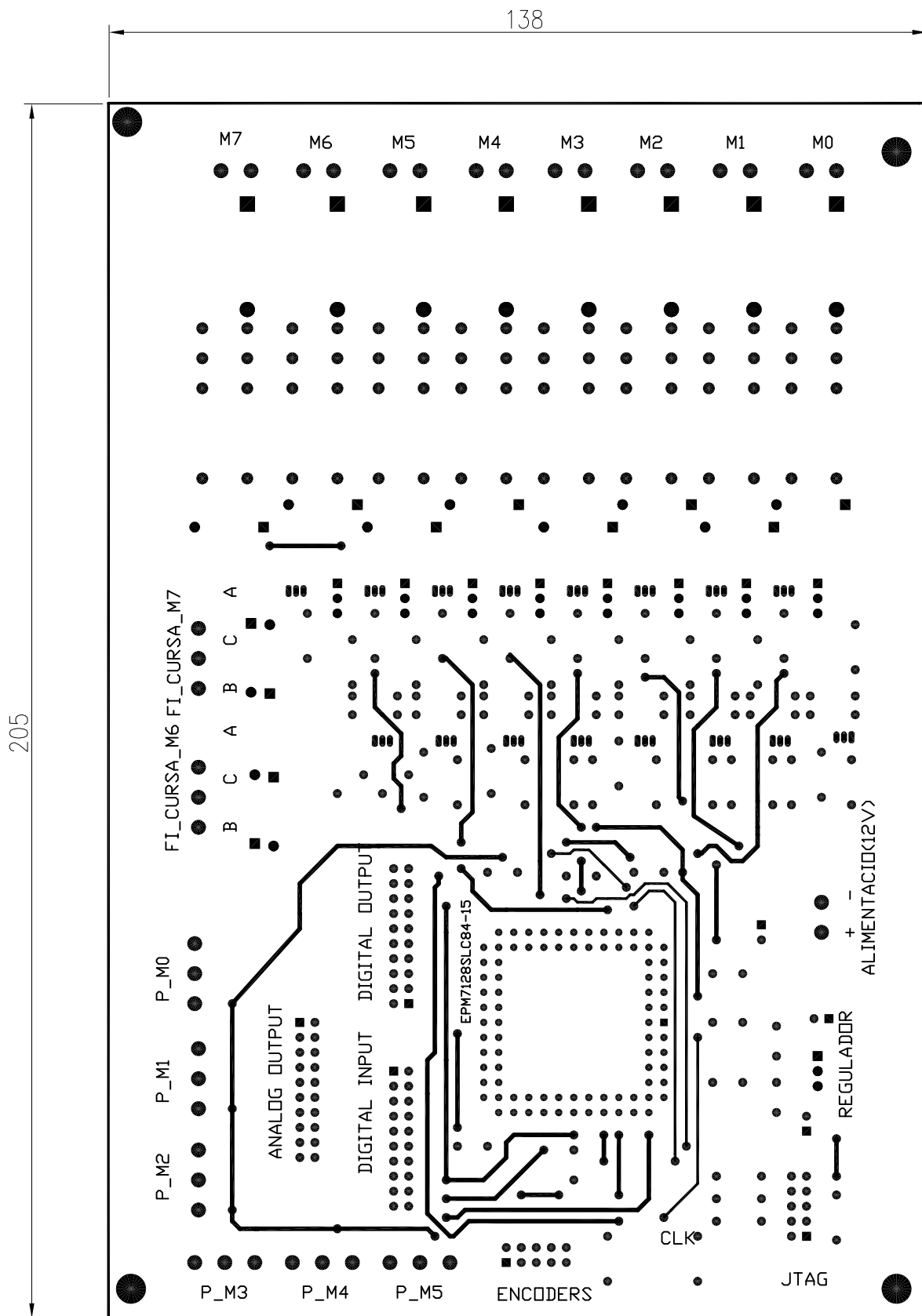

	Data	Nom	Signatura	 UdG	Escola politècnica Superior
Dibuixat	26-10-05	Pere Amadó			
Compro.	05-05.06	Pere Amadó			
Escala <b>1/1</b>	<h1>CAPA TOP PLACA</h1>				Nº plànol 5 Substitueix a: Especialitat ETIEI

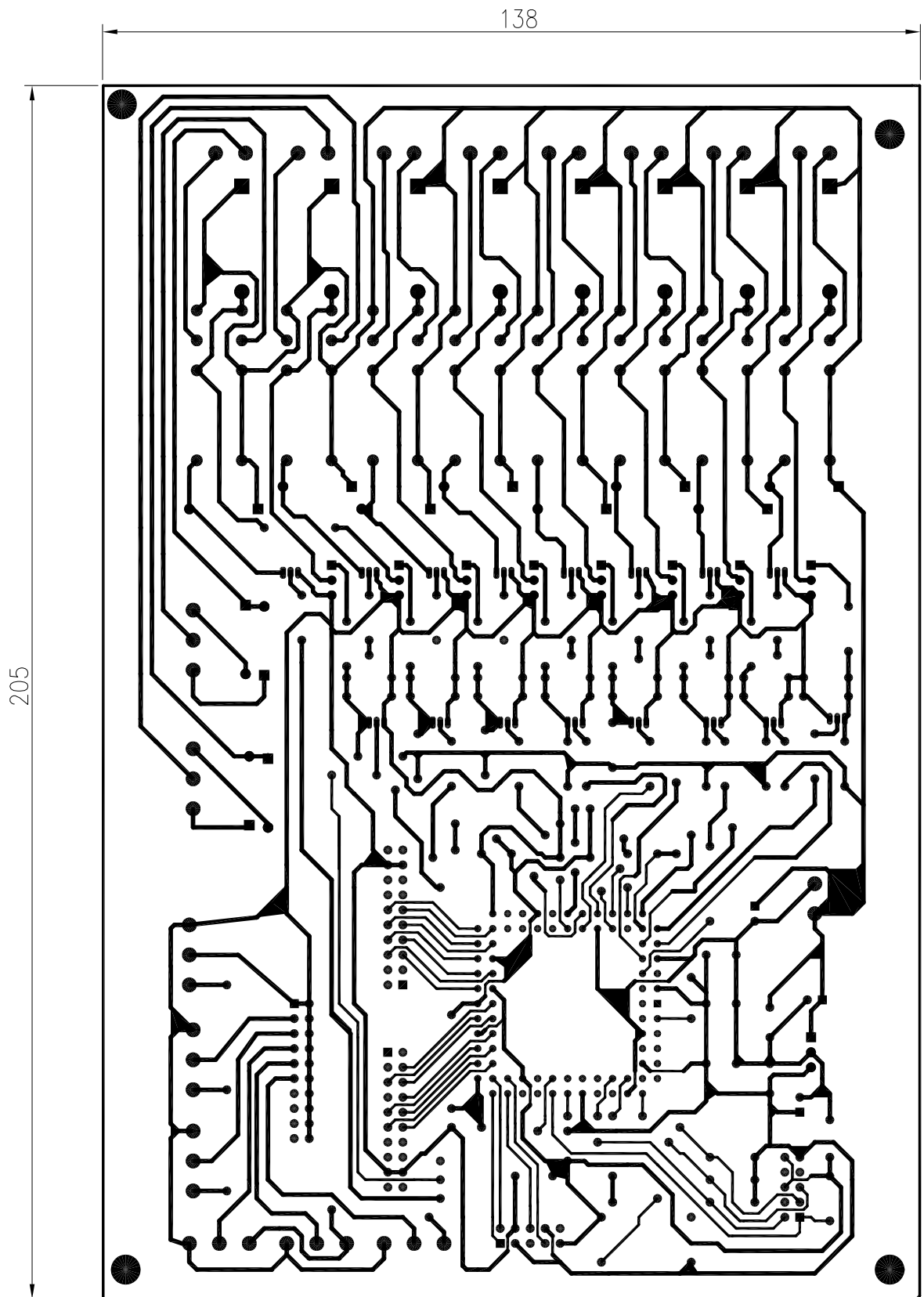



	Data	Nom	Signatura	 UdG	Escola politècnica Superior
Dibuixat	26-10-05	Pere Amadó			
Compro.	05-05-05	Pere Amadó			
Escala <b>1/1</b>	<h1>CAPA BOTTOM PLACA</h1>				Nº plànoi 6 Substitueix a: Especialitat ETIEI

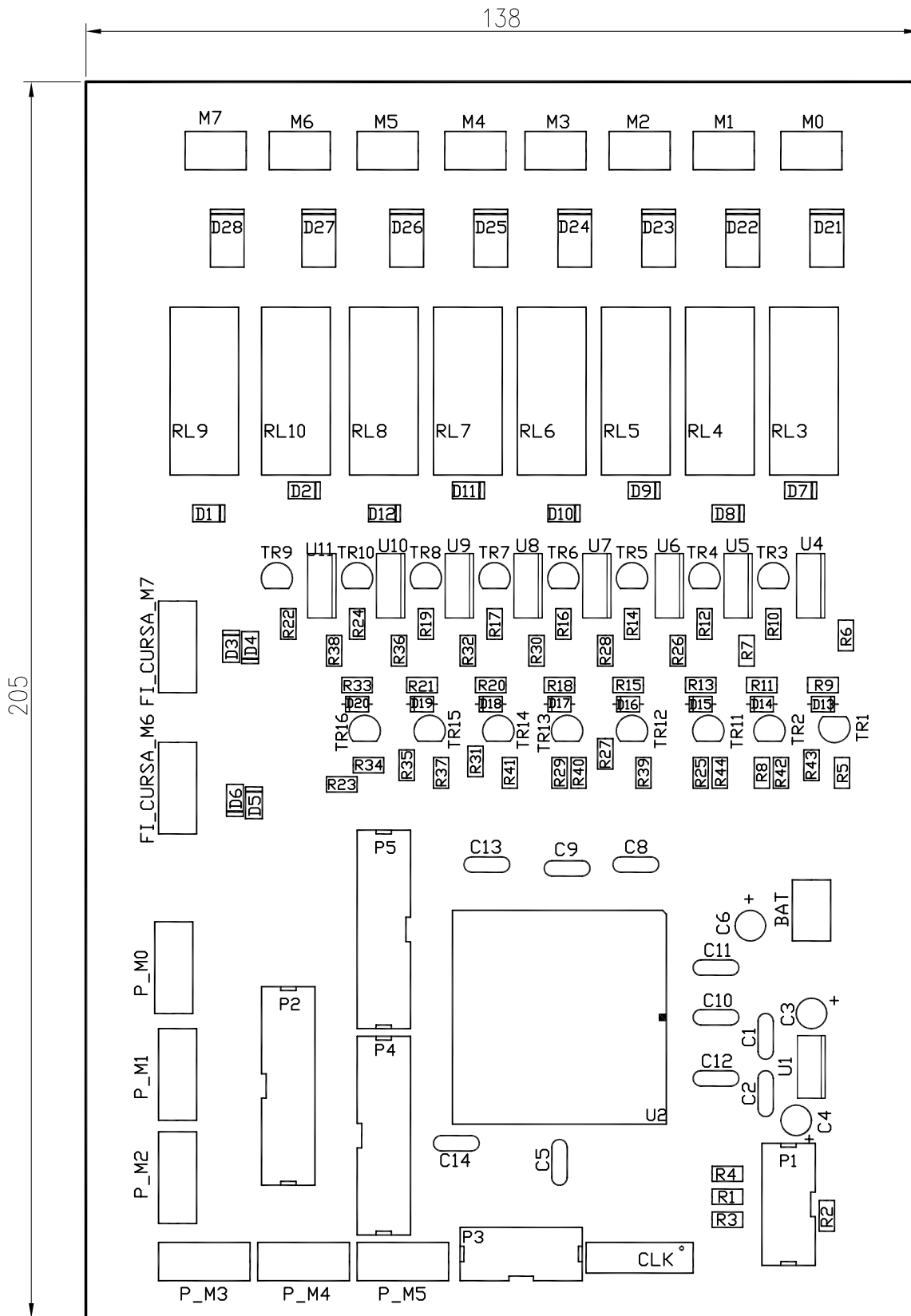



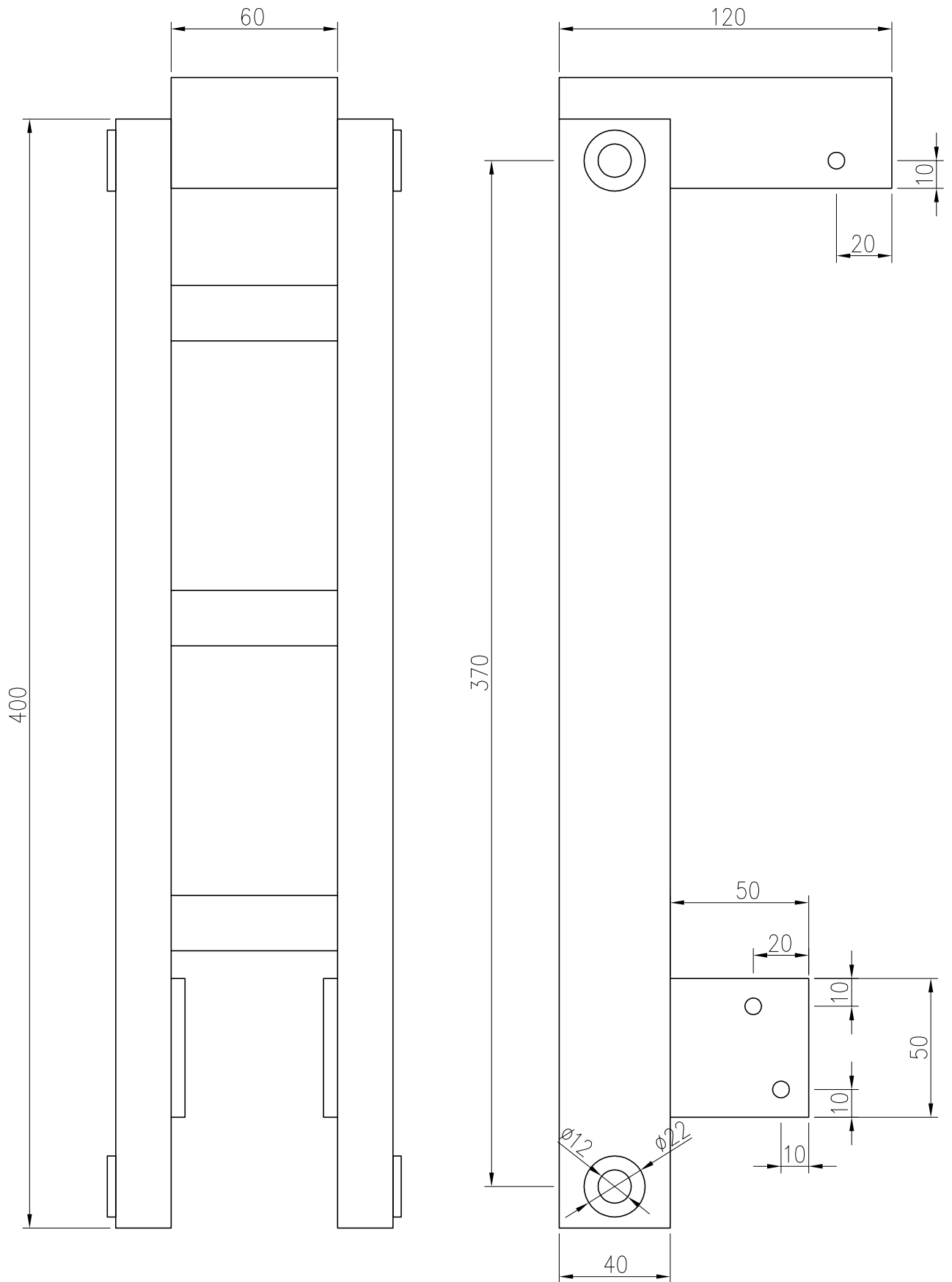

	Data	Nom	Signatura	 Escola politècnica Superior
Dibuixat	28-09-05	Pere Amadó		
Compro.	26-12-05	Pere Amadó		
Escala <b>1/1</b>	<b>DISPOSICIÓ COMPONENTS</b>			Nº plànol 7 Substitueix a: Especialitat ETIEI

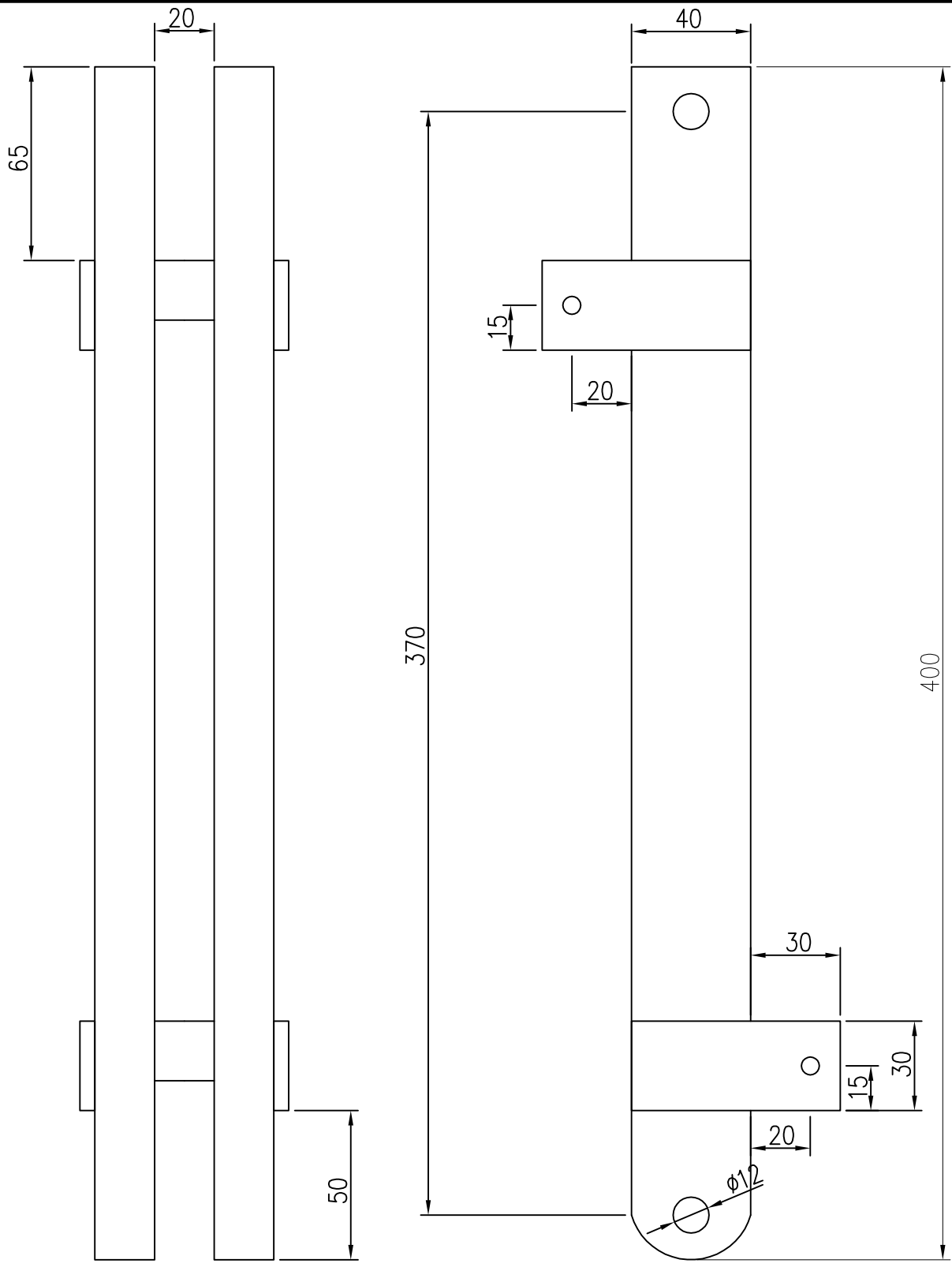

	Data	Nom	Signatura	 <b>UdG</b>	Escola politècnica Superior
Dibuixat	19-08-05	Jeroni Salellas			
Compro.	26-12-05	Pere Amadó			
Escala <b>1/2</b>	<h1>CUIXA</h1>				Nº plànol A1
					Substitueix a:
					Especialitat ETIEI



	Data	Nom	Signatura	 Escola politècnica Superior
Dibuixat	19-08-99	Jeroni Salellas		
Compro.	26-12-05	Pere Amadó		
Escala <b>1/2</b>	<b>TÍBIA - PERONÉ</b>			N° plànol A2 Substitueix a: Especialitat ETIEI

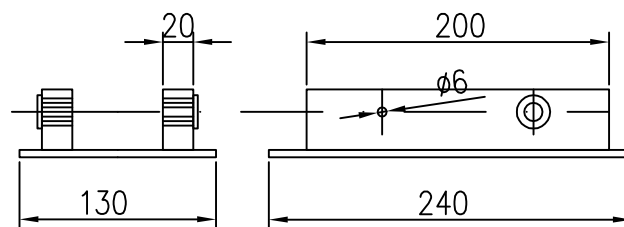

	Data	Nom	Signatura	 <b>UdG</b>	Escola politècnica Superior
Dibuixat	19-08-99	Jeroni Salellas			
Compro.	26-12-05	Pere Amadó			
Escala <b>1/5</b>	<b>PEU</b>				N° plànol A3 Substitueix a: Especialitat ETIEI

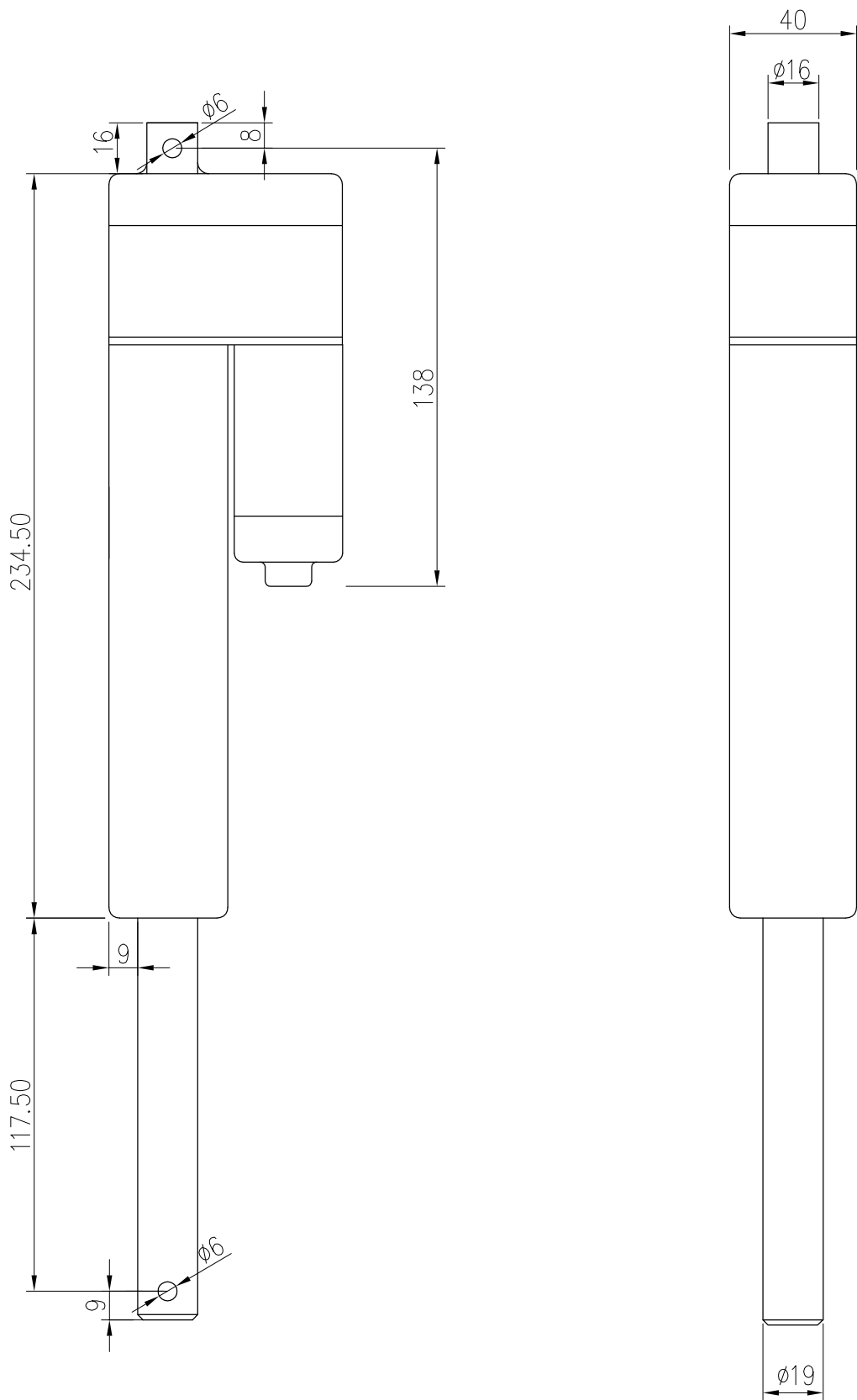

	Data	Nom	Signatura	 <b>UdG</b>	Escola politècnica Superior
Dibuixat	26-12-05	Pere Amadó			
Compro.	26-12-05	Pere Amadó			
Escala <b>1/2</b>	<b>ACTUADOR LINEAL</b>				Nº plànoi A4 Substitueix a: Especialitat ETIEI