

Forming of mechanically interlocked aluminium and carbon fibre reinforced polymer parts with complex geometry

LATORRE Núria^{1,2,a*}, CASELLAS Daniel^{1,3,b}, COSTA Josep^{2,c},
GARCIA-LLAMAS Eduard^{1,d} and PUJANTE Jaume^{1,e}

¹Eurecat, Technological Centre of Catalonia, Parc Tecnològic del Vallès, Av. Universitat Autònoma, 23 – 08290 Cerdanyola del Vallès, Spain

²AMADE Research Group, Polytechnic School, University of Girona, Campus Montilivi s/n, E-17003 Girona, Spain

³List Division of Mechanics of Solid Materials, Luleå University of Technology, 971 87 Luleå, Sweden

^anuria.latorre@eurecat.org, ^bdaniel.casellas@eurecat.org, ^cjosep.costa@udg.edu,
^deduard.garcia@eurecat.org, ^ejaume.pujante@eurecat.org

Keywords: Metal, CFRP, Punching, Stamping, Automotive

Abstract. Forming of aluminium-CFRP hybrid structures into complex shapes is key to decrease environmental impact in automotive industry. However, challenges such as preserving joint integrity after forming operations must be assessed. Therefore, the authors of this work have cold stamped hybrid aluminium-CFRP panels into omega shaped profiles with and without a mechanical interlocking joining technology. The effect of lubricant application, of the CFRP positioning (inside or outside the omega profile), and of the number of mechanical joints were studied. It was concluded that it is possible to cold stamp aluminium-CFRP prepreg panels even with mechanical joints into complex profiles when lubricant is used. Moreover, the position of the CFRP prepreg has a strong impact on the flange springback of the stamped part.

Introduction

Nowadays, environmental demands are pushing automotive manufacturers to reduce vehicle weight without compromising its performance and safety. An interesting strategy to achieve that is multi-material design of structural parts of vehicle's components, giving a crucial role to the joining between dissimilar lightweight materials [1].

However, conventional joining strategies between metals and Carbon Fibre Reinforced Polymers (CFRP) either require drilling a hole in the composite material, which can lead to damages causing a decrease on the load bearing capacity of the components, or the increase of the weight of the part with the incorporation of fasteners [2–6]. Alternative mechanical joining strategies have been developed to overcome these drawbacks, but they involve complex and costly processing [7].

This led the authors of this work to develop a mechanical joining strategy between aluminium and CFRP consisting of a single-step punching process. Such process is simple, does not perforate the composite material, nor incorporate any extra weight on the part, and can be easily implemented in the automotive manufacturing lines [8]. Such mechanical interlocking joint improved the shear strength of the co-cured joint between 41 % and 57 %, and the absorbed energy between 94 % and 205 % for the studied materials (Fig. 1).

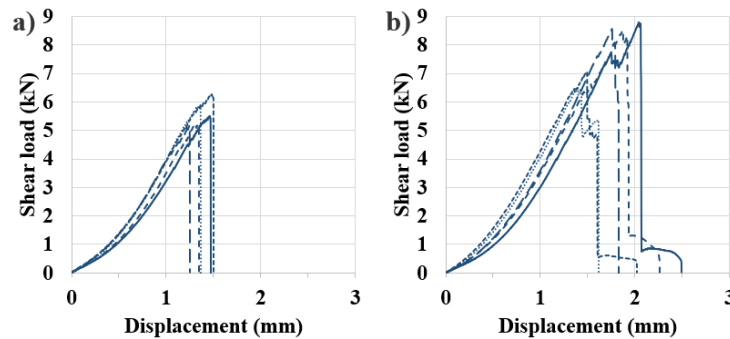

Fig. 1. Load-displacement curved obtained in the Single Lap Shear test for a) co-cured reference aluminium-CFRP specimens without mechanical interlocking joint and b) co-cured aluminium-CFRP specimens with the developed mechanical interlocking joint [8].

However, previous studies on the developed joint were performed at a coupon level in a flat and simple geometry. Yet, in order to scale-up the process, such dissimilar joints need to be able to be formed into complex geometries, if possible, adapting conventional forming processes of the constituent materials to multi-material forming.

Cold forming of aluminium consists of using pressure to force a solid metal blank to deform plastically into the tooling shape. It is performed at temperatures which leave the aluminium microstructure unaffected, does not produce scrap material, results in an acceptable surface finish and it offers better tolerances than hot forming [9]. On the other hand, it requires higher pressure and energy, since aluminium has a poor formability at room temperature [10] and it is known to suffer from abrasive and adhesive wear even at room temperature [11]. The use of lubricants and ceramic PVD (Physical Vapor Deposition) coatings on the tooling delays galling and decreases friction [12,13], being adequate lubrication the most important factor for galling prevention [14].

Feasibility of deep drawing of metal-composite sandwich plates has been assessed in previous literature [15–17]. Conclusions were than when forming the sandwich panels at room temperature, fracture of the aluminium takes place, while an increase of the preheat temperature decreases the severity of failure and increases wrinkling on the aluminium.

This study investigates the viability of cold stamping hybrid aluminium-CFRP prepreg parts with and without the dissimilar joint generated through a punching process, into omega shaped profiles. Additionally, the feasibility of stamping these profiles with and without lubricant application is also considered, since the application of lubricant must be performed carefully in order not to contaminate the uncured epoxy matrix in the CFRP prepreg. Moreover, challenges such as galling, necking, edge fracture and the change in the springback behavior are assessed.

Materials and methods

Materials. 2,0-mm-thick rolled sheets of AA5754 H111 aluminium alloy were used in this work. This material is commonly used in the automotive industry as a non-heat-treatable aluminium alloy to produce medium strength parts due to its high formability and corrosion resistance.

The selected CFRP was a 0,65-mm-thick twill 2x2 carbon fibre prepreg of 650 g/m² with a 36 % in weight of MTC275 toughened epoxy matrix.

Specimen preparation. Sample processing consisted in three steps: preparation of blanks, joining by punching and eventually stamping of omega components. Different types of specimens were manufactured considering three variables. The resulting test matrix is described in Table 1.

- Position of the CFRP reinforcement: no reinforcement (0), reinforcement inside the omega profile and reinforcement outside the omega profile (o-).

- Lubricant: without (N) and with lubricant (L). In all cases, lubricant was only applied on the aluminium surface of the specimens, meaning in specimens where the CFRP was placed inside the omega profile, the lubricant was placed outside and vice-versa.
- Mechanical joints: specimens with no mechanical joints (0, if it is only aluminium or 1, if it is aluminium and CFRP), specimens with one mechanical joint (2) and specimens with three mechanical joints (3). For the specimens with three mechanical joints, a 20 mm separation space was left between joints.

Four specimens of each type were manufactured. For the same specimen type, the order in which each specimen was stamped was considered, since it is relevant to evaluate adhesive friction and galling of the stamped specimens.

Table 1. Description of the different types of specimens. Inside and outside refer to the side of the omega shaped profile where the CFRP or the lubricant were applied for each specimen type.

Specimen	Aluminium	CFRP	Lubricant	Number of mechanical joints
N0	Yes	None	None	0
N1	Yes	Inside	None	0
N3	Yes	Inside	None	3
L0	Yes	None	Outside	0
L1	Yes	Inside	Outside	0
L2	Yes	Inside	Outside	1
L3	Yes	Inside	Outside	3
o-L0	Yes	None	Inside	0
o-L1	Yes	Outside	Inside	0
o-L2	Yes	Outside	Inside	1

Blank preparation and joining by punching. 125 mm x 250 mm blanks were cut from the aluminium sheet. An uncured CFRP prepreg layer was placed on the blanks, except for specimens N0, L0 and o-L0 (Table 1).

The described mechanical joint was then added to some of the specimens in addition to the adhesive joint coming from the co-bonding of the composite epoxy matrix to the aluminium.

The joint was performed by laying up one uncured CFRP prepreg layer on top of an aluminium sheet and placing a silicone paper layer on top of the CFRP to avoid the uncured epoxy matrix to stick to the punch. Then, the whole system was punched with the CFRP facing the punch side of the set-up (Fig. 2a). The punching was stopped when the aluminum sheet was completely punched but the carbon fibres were not. Instead, the fibres were pressed against the aluminium hole walls, generating a mechanical interlock between both materials (Fig. 2b).

This procedure was performed using a punching tooling mounted on a universal testing machine with a 50 kN loadcell. Punching was performed at a constant speed of 10 mm/min, using a punch with a 10 mm diameter (d_p , Fig. 2a), as commonly found in the automotive industry [10], and a 0 mm fillet radius (R , Fig. 2a). A die diameter (d_d , Fig. 2a) of 11,3 mm was used, leading to a clearance of the 24 %, and punching was stopped at a 2,6 mm stroke.

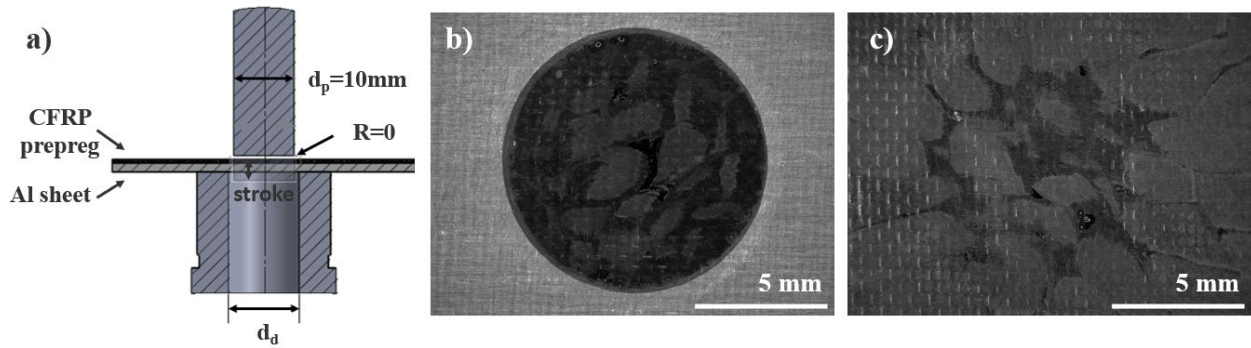

Fig. 2. a) Schematic cross-section of the punching process, b) cured joint from the aluminium sheet side and c) cured joint from the CFRP side.

Stamping. The flat sheets were cold formed into an omega shaped profile (Fig. 3) at 30 Tn using a stamping tooling for hot work steel mounted on a Hydrogarne 150 Tn press. Since joining and stamping take place in an uncured state of the prepreg, delamination and tearing of the CFRP during this process are prevented.

Lubricant was applied prior to stamping. For the lubricated specimens, the RENOFORM 10ALWF 40LB (20 %) lubricant was applied with a roller on the aluminum side of the specimen. However, in specimens featuring mechanical joints, a cautious approach was taken to leave the central 15 mm width unlubricated. This measure aimed to prevent any contamination of the composite epoxy matrix with lubricant. Additionally, a layer of silicon paper was placed atop the CFRP prepreg to mitigate the risk of the epoxy matrix adhering to the stamping tooling.

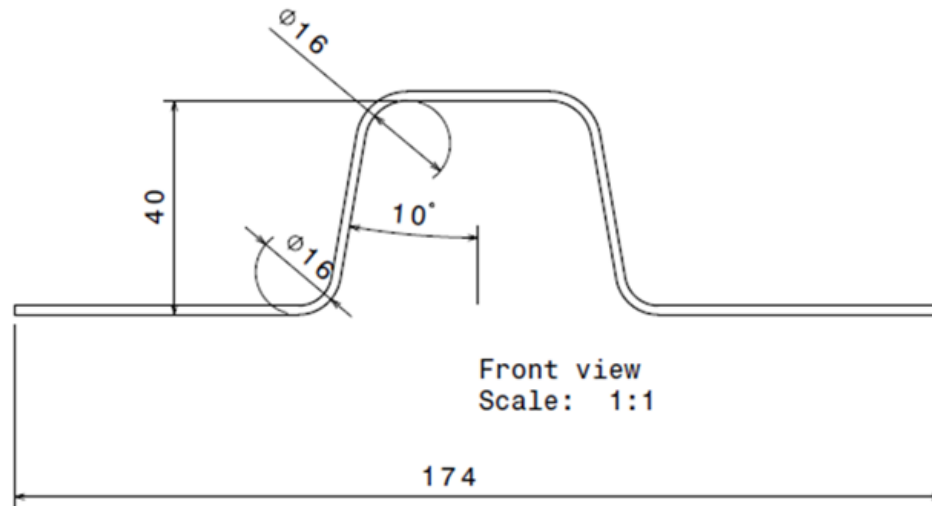

Fig. 3. Schematic drawing of the stamped omega profile (units in mm).

Joint characterization. After stamping, the joint diameter in the x-direction and in the y-direction (Fig. 4) was measured using a caliper to assess joint deformation.

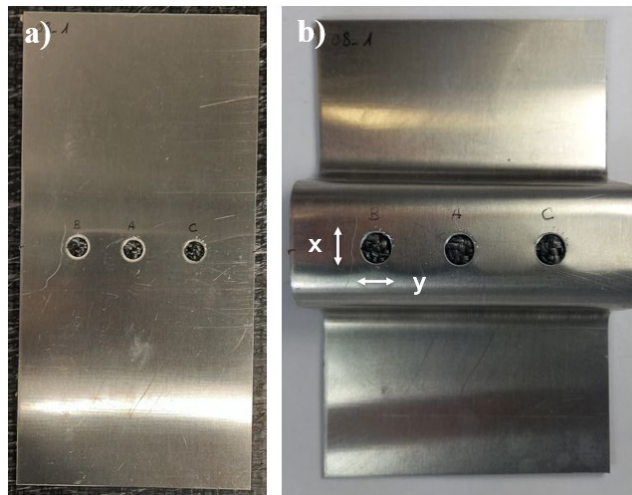

Fig. 4. a) L3 specimen after punching and prior to stamping and b) L3 specimen after stamping. Joint deformation is inspected in the stipulated x- and y-directions.

Springback measurement. The flange springback of the specimens was assessed by measuring the θ angle (Fig. 5) with an angle protractor. Thus, higher θ angle correlates to a higher amount of flange springback. A hot stamped Usibor 1500 specimen is used as a no-springback reference (Ref).

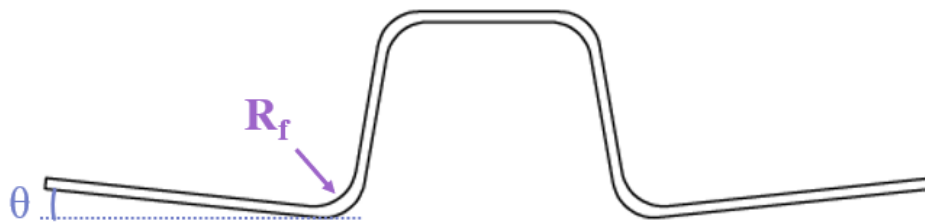

Fig. 5. θ Angle measured in order to assess specimens flange springback. R_f corresponds with the radius with the highest friction.

Results

All specimens could be stamped regardless of the material and joining configuration. However, aluminium and CFRP specimens with three mechanical joints stamped without lubricant (N3) underwent severe necking and edge cracking after the second stamping, being these phenomena more severe at each consecutive stamping (Fig. 6a). These defects were not seen in the analogous specimens stamped with lubricant (L3, Fig. 6b).

When looking at the joint diameter (Fig. 6 and Fig. 7), it can be seen that the diameter in the y-direction remains constant when stamping with (L3, Fig. 6b and Fig. 7d) and without lubrication (N3, Fig. 6a and Fig. 7b) regardless of the number of stamps. However, the joint diameter in the x-direction increases considerably with each consecutive stamping for specimens stamped without lubricant (N3, Fig. 6a and Fig. 7a), meaning the joint is highly deformed in this direction during stamping, and only the first specimen stamped has the same diameter in both x- and y- directions. Nevertheless, the joint diameter in the x-direction of the specimens stamped with lubricant (L3, Fig. 6b and Fig. 7b) remains constant regardless of the number of stamps, and it is the same than the joint diameter in the y-direction.

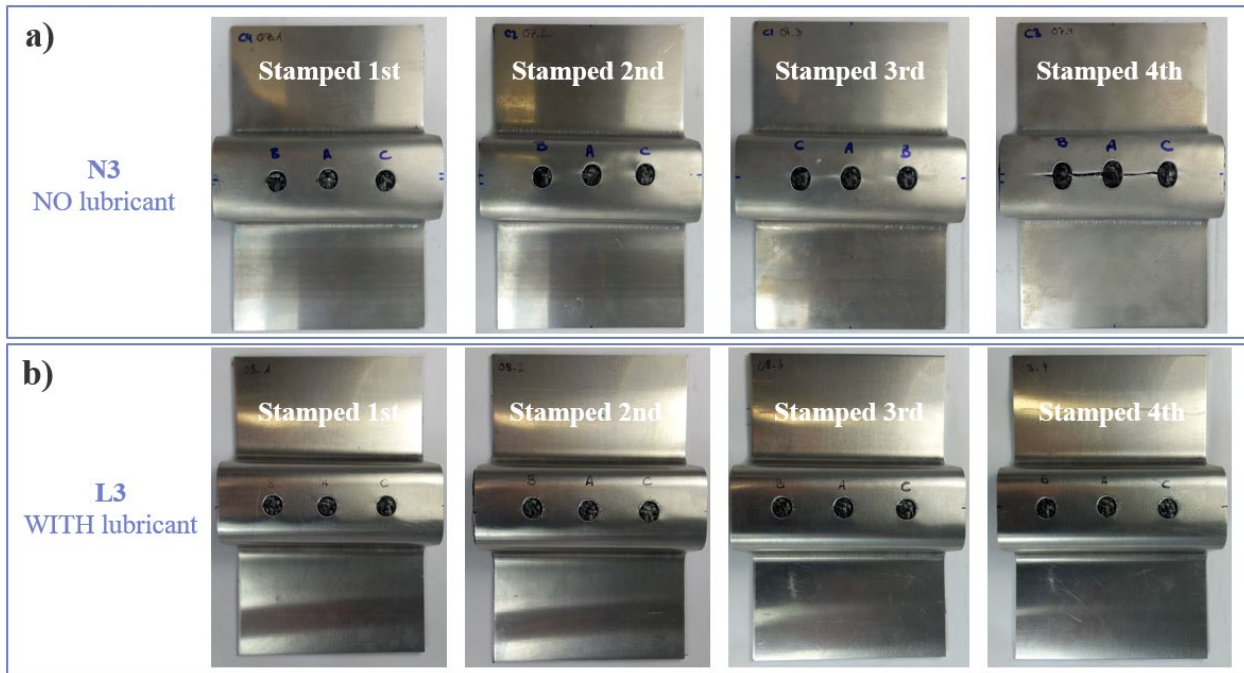

Fig. 6. Stamped aluminium and CFRP specimens with three mechanical joints by stamping order a) stamped without any lubricant and b) stamped with lubricant.

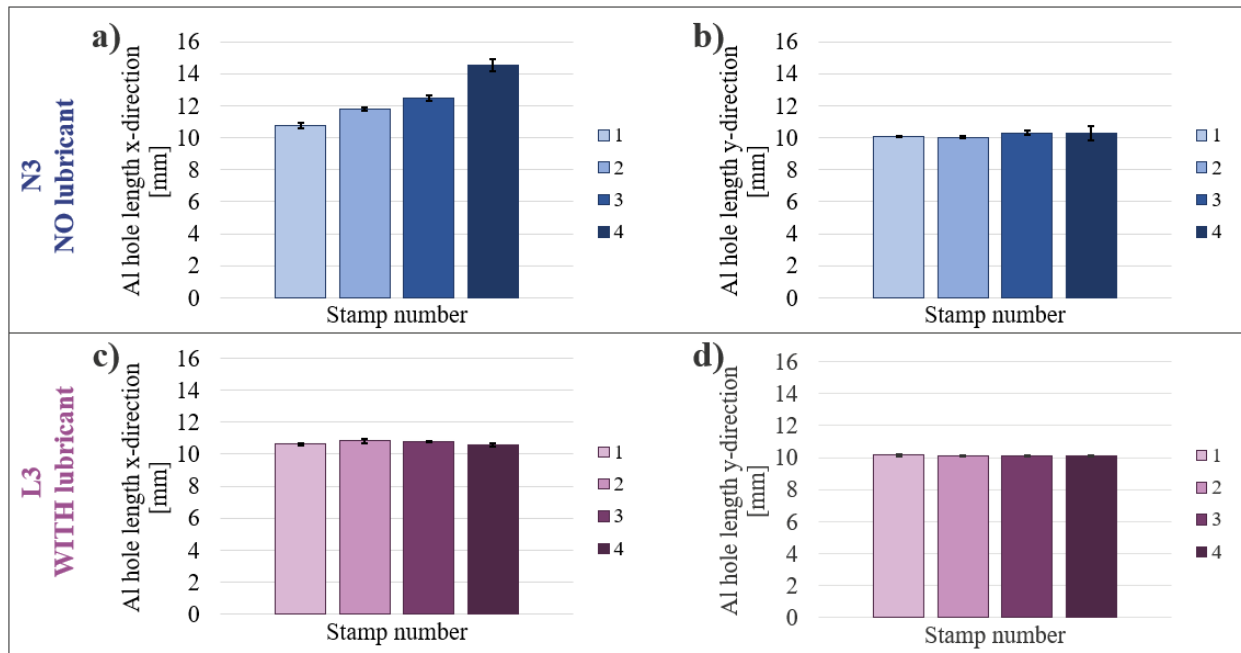

Fig. 7. Joint diameter after stamping in x- and y-direction for specimens with 3 mechanical joints. For specimens N3 (without lubricant) a) diameter in x-direction and b) diameter in y-direction. For specimens L3 (with lubricant) c) diameter in x-direction and d) diameter in y-direction.

Side images of the stamped specimens can be observed in Fig. 8. Visual inspection shows that aluminium without CFRP (N0/ Fig. 8a, L0/ Fig. 8d and o-L0/ Fig. 8h) exhibit a high amount of springback. When adding a CFRP layer in the inside of the omega shaped profile however, the springback is drastically reduced (N1/ Fig. 8b, N3/ Fig. 8c, L1/ Fig. 8e, L2/ Fig. 8f and L3/ Fig. 8g). Nevertheless, when adding a CFRP layer on the outer part of the profile, such reduction of the springback is not visually observed (o-L1/ Fig. 8i and o-L2/ Fig. 8j).

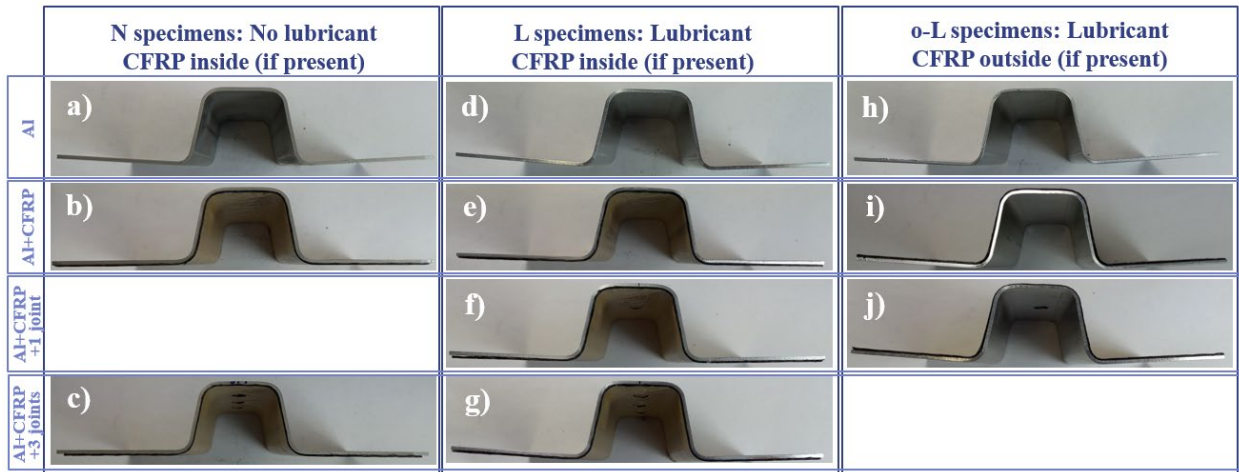

Fig. 8. Side images of stamped specimens. All images correspond to the 4th stamped specimen of each type. a) N0, b) N1, c) N3, d) L0, e) L1, f) L2, g) L3, h) o-L0, i) o-L1 and j) o-L2.

θ angle measures for each specimen type can be seen in Fig. 9. The measured angles were in agreement with the visual inspection, since aluminium specimens without CFRP (N0/ Fig. 9a, L0/ Fig. 9b and o-L0/ Fig. 9c) and specimens where CFRP had been placed in the outer part of the omega profile (o-L1 and o-L2/ Fig. 9c) have a 3° θ angle. However, specimens in where the CFRP was placed inside the omega profile (N1 and N3/ Fig. 9a, L1, L2 and L3/ Fig. 9b), the θ angle was reduced, implying a decrease of the springback. It can also be seen that in specimens where the CFRP was inside the profile and lubricant was applied, the θ angle increases with the amount of mechanical joints (L1, L2 and L3/ Fig. 9b), while this effect was not observed in the analogous specimens where lubricant was not applied (N1 and N3/ Fig. 9a).

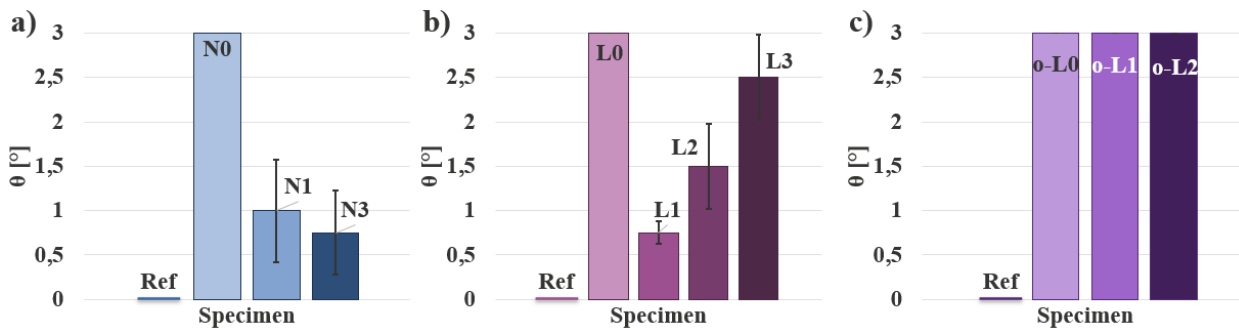

Fig. 9. θ angle measured for each type of specimens.

Discussion

Results showed that it is possible to cold stamp aluminium with an uncured layer of CFRP prepreg into a complex omega-shaped profile.

However, specimens which were stamped without lubricant (N3) exhibit scratches, necking and edge cracking, after the second stamping operation. The severity of these defects escalated with each successive forming operation, as they were induced by galling. (Fig. 6). Galling is the transfer of aluminium from the stamped part to the tooling surface, followed by hardening of the transferred aluminium by oxidation, work hardening or grain refinement [9]. Thus, in the following stampings, the hardened aluminium increases abruptly the frictional force due to microscopic welding [18], causing scratches in the areas of the part which undergo the most extensive expansion. Therefore, the aluminium hole of the mechanical joint got deformed, becoming wider in the direction of the sheet deformation (x-direction). This caused necking on the perpendicular direction (y-direction)

due to the large amount of strain localized in the narrowest section of the geometry (Fig. 6a), resulting in eventual edge cracking.

The mentioned defects were not present in specimens stamped using lubricant (L3, Fig. 6), since lubrication decreases friction and delays galling [14]. Therefore, even specimens with mechanical joints could be stamped into a complex shape without causing deformation, necking or edge fracture in the vicinity of the aluminium hole, with the use of proper lubrication.

When approaching springback, it was clearly seen that adding an uncured CFRP prepreg layer in the inner part of the omega profile reduced the springback comparing to when stamping aluminium without any CFRP layer. However, when the CFRP prepreg was added on the outer part of the profile, springback appeared to be quite similar to stamping aluminium without CFRP. Clearance between the punch and the die directly affects the drawing force and thus, springback behavior [19]. Nevertheless, the clearance was reduced in the same amount when adding the CFRP, regardless of its position, and is therefore not enough to explain the springback reduction when placing the CFRP in the inner part of the omega. However, this phenomenon can be explained with the fact that the carbon fibres have a high tensile strength and very small deformation (1 %) and the uncured CFRP prepreg exhibits tacky behavior due to the uncured epoxy matrix. Because of that, when placing the CFRP prepreg on the inner part of the omega profile, in the radius with the highest amount of friction (R_f , Fig. 5) the carbon fibres will be in tension and adhered to the aluminium surface due to its tackiness. Therefore, this configuration will restrict the aluminium elastic recovery, thus minimizing flange springback. Nevertheless, when the CFRP prepreg is placed outside the omega profile, the carbon fibres in R_f are compressed. Consequently, elastic recovery of the aluminium in this configuration is not restricted and springback is maintained.

The number of mechanical joints in lubricated specimen also seemed to have an effect on the magnitude of the springback. The higher the number of mechanical joints, the higher the springback. This could be due to the area of CFRP prepreg not adhered to the aluminum in each mechanical joint being more free to move than the rest of the specimen. That involves less restriction to the elastic recovery of the aluminium and, in consequence, larger springback. However, such effect is not observed in the analogous specimens stamped without lubricant, which might be related to the local temperature increase due to friction during stamping, leading to a drop of resin viscosity and tackiness. Clarification of this issue requires further studies.

Conclusions

The main conclusion of this work is that it is possible to cold stamp aluminium with uncured layers of CFRP prepreg into a complex omega-shaped profile. Nevertheless, specimens featuring mechanical joints must be stamped with lubricant to prevent galling and the subsequent rise in frictional force. This precautionary measure helps avert issues such as necking and edge cracking, particularly after the second forming cycle.

Since two dissimilar materials are being stamped at the same time, material lay-up affects the springback behavior of the stamped part. When the CFRP is placed in the inner part of the omega profile, the springback of the aluminium is highly reduced, while this effect is unseen when the CFRP is found on the outer part of the omega profile.

The number of mechanical joints also influences the springback behavior when lubricant is used during the forming process. The lower the number of mechanical joints, the lower the springback of the stamped part.

References

- [1] J. Fleischer and J. Nieschlag, Introduction to CFRP-metal hybrids for lightweight structures, *Prod. Eng.*, vol. 12, no. 2, pp. 109–111, 2018. <https://doi.org/10.1007/s11740-018-0825-0>

- [2] A. Pramanik *et al.*, Joining of carbon fibre reinforced polymer (CFRP) composites and aluminium alloys – A review, *Compos. Part A Appl. Sci. Manuf.*, vol. 101, pp. 1–29, 2017. <https://doi.org/10.1016/j.compositesa.2017.06.007>
- [3] Y. Ouyang and C. Chen, Research advances in the mechanical joining process for fiber reinforced plastic composites, *Compos. Struct.*, vol. 296, no. March, p. 115906, 2022. <https://doi.org/10.1016/j.compstruct.2022.115906>
- [4] A. Galińska, Mechanical joining of fibre reinforced polymer composites to metals—a review. Part I: Bolted joining, *Polymers (Basel)*, vol. 12, no. 10, pp. 1–48, 2020. <https://doi.org/10.3390/polym12102252>
- [5] G. Di Franco, L. Fratini, and A. Pasta, Analysis of the mechanical performance of hybrid (SPR/bonded) single-lap joints between CFRP panels and aluminum blanks, *Int. J. Adhes. Adhes.*, vol. 41, pp. 24–32, 2013. <https://doi.org/10.1016/j.ijadhadh.2012.10.008>
- [6] F. Lambiase and D. C. Ko, Feasibility of mechanical clinching for joining aluminum AA6082-T6 and Carbon Fiber Reinforced Polymer sheets, *Mater. Des.*, vol. 107, pp. 341–352, 2016. <https://doi.org/10.1016/j.matdes.2016.06.061>
- [7] A. Galińska and C. Galiński, Mechanical joining of fibre reinforced polymer composites to metals-A review. Part II: Riveting, clinching, non-adhesive form-locked joints, pin and loop joining, *Polymers (Basel)*, vol. 12, no. 8, 2020. <https://doi.org/10.3390/POLYM12081681>
- [8] N. Latorre, D. Casellas, and J. Costa, A punching process to join metal sheets and fibre reinforced polymer composites by mechanical interlocking, *Compos. Part A*, vol. 175, no. July, p. 107744, 2023. <https://doi.org/10.1016/j.compositesa.2023.107744>
- [9] J. Heinrichs and S. Jacobson, The influence from shape and size of tool surface defects on the occurrence of galling in cold forming of aluminium, *Wear*, vol. 271, no. 9–10, pp. 2517–2524, 2011. <https://doi.org/10.1016/j.wear.2011.01.077>
- [10] K. Lange, Handbook of Metal Forming, *J. Appl. Metalwork.*, vol. 4, no. 2, p. 188, 1986. <https://doi.org/10.1007/BF02834383>
- [11] J. Pujante, L. Pelcastre, M. Vilaseca, D. Casellas, and B. Prakash, Investigations into wear and galling mechanism of aluminium alloy-tool steel tribopair at different temperatures, *Wear*, vol. 308, no. 1–2, pp. 193–198, 2013. <https://doi.org/10.1016/j.wear.2013.06.015>
- [12] M. Vilaseca, S. Molas, and D. Casellas, High temperature tribological behaviour of tool steels during sliding against aluminium, *Wear*, vol. 272, no. 1, pp. 105–109, 2011. <https://doi.org/10.1016/j.wear.2011.07.007>
- [13] M. Vilaseca, J. Pujante, G. Ramírez, and D. Casellas, Investigation into adhesive wear of PVD coated and uncoated hot stamping production tools, *Wear*, vol. 308, no. 1–2, pp. 148–154, 2013. <https://doi.org/10.1016/j.wear.2013.07.003>
- [14] J. Heinrichs and S. Jacobson, Laboratory test simulation of aluminium cold forming - influence from PVD tool coatings on the tendency to galling, *Surf. Coatings Technol.*, vol. 204, no. 21–22, pp. 3606–3613, 2010. <https://doi.org/10.1016/j.surfcoat.2010.04.025>
- [15] S. F. Hwang and Y. R. Li, Deep Drawing Behavior of Metal-Composite Sandwich Plates, *Materials (Basel)*, vol. 15, no. 19, 2022. <https://doi.org/10.3390/ma15196612>
- [16] J. Gresham, W. Cantwell, M. J. Cardew-Hall, P. Compston, and S. Kalyanasundaram, Drawing behaviour of metal-composite sandwich structures, *Compos. Struct.*, vol. 75, no. 1–4, pp. 305–312, 2006. <https://doi.org/10.1016/j.compstruct.2006.04.010>
- [17] T. Heggemann and W. Homberg, Deep drawing of fiber metal laminates for automotive lightweight structures, *Compos. Struct.*, vol. 216, no. December 2018, pp. 53–57, 2019.

<https://doi.org/10.1016/j.compstruct.2019.02.047>

[18] K. Dohda, M. Yamamoto, C. Hu, L. Dubar, and K. F. Ehmann, Galling phenomena in metal forming, *Friction*, vol. 9, no. 4, pp. 665–685, 2021. <https://doi.org/10.1007/s40544-020-0430-z>

[19] A. Wang *et al.*, Springback analysis of AA5754 after hot stamping: experiments and FE modelling, *Int. J. Adv. Manuf. Technol.*, vol. 89, no. 5–8, pp. 1339–1352, 2017. <https://doi.org/10.1007/s00170-016-9166-3>