

Treball final de grau

Estudi: Grau en Enginyeria Electrònica Industrial i Automàtica

Títol: Paletització d'una línia productiva.

Document: 2. Plànols

Alumne: Gerard Falgueras Regincós

Tutor: Marc Palom Agusti

Departament: Enginyeria Elèctrica, Electrònica i Automàtica

Àrea: Enginyeria de Sistemes i Automàtica

Convocatòria (mes / any): setembre / 2023

ÍNDEX

1. PLANTA
2. UBICACIÓ SENSORS
3. POTÈNCIA 1
4. POTÈNCIA 2
5. POTÈNCIA 3
6. POTÈNCIA ROBOT
7. PLC ALIMENTACIÓ
8. HMI ALIMENTACIÓ
9. SEGURETAT
10. PLC ENTRADES 1
11. PLC ENTRADES 2
12. PLC ENTRADES 3
13. PLC SORTIDES 1
14. PLC SORTIDES 2
15. BORNES =QP+QP-X1
16. BORNES =QP+QP-X3
17. BORNES =QP+QP-X4
18. BORNES =QP+QP-X6
19. BORNES =QP+QP-X9
20. BORNES =QP+QP-X10
21. BORNES =QP+QP-X11
22. BORNES =QP+QP-X11
23. BORNES =QP+QP-X12
24. BORNES =QP+QP-X13
25. BORNES =QP+QP-X14
26. BORNES =QP+QP-XR
27. BORNES =QP+QP-XR1
28. BORNES =QP+QP-XR2
29. PNEUMÀTICA

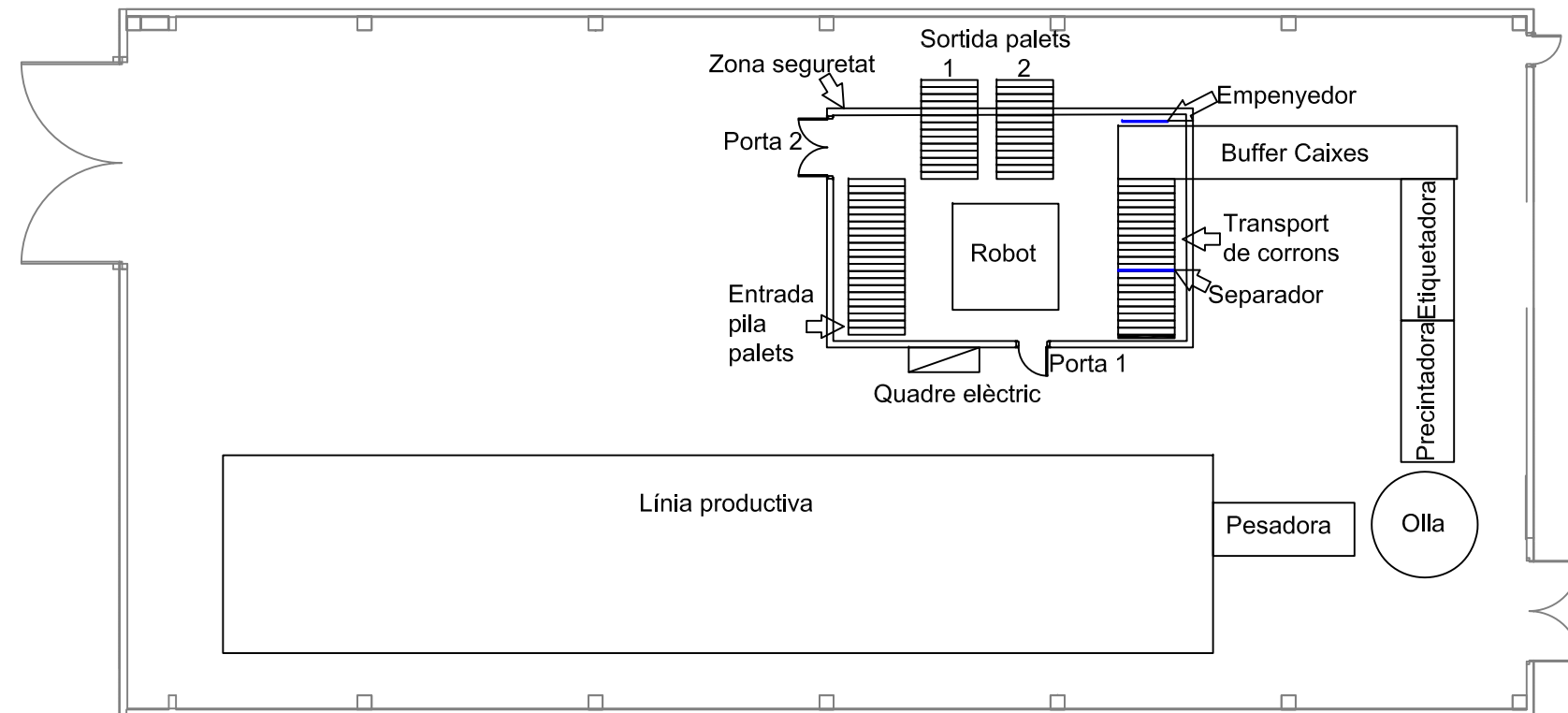

	Data	Nom	Signatura	
Dibuixat	04/09/23	G. Falgueras		
Comprovat	04/09/23	G. Falgueras		
Escala	PLANTA			Nº plànol: 1
1:200				Sustitueix a:
				Especialitat: GEEIA

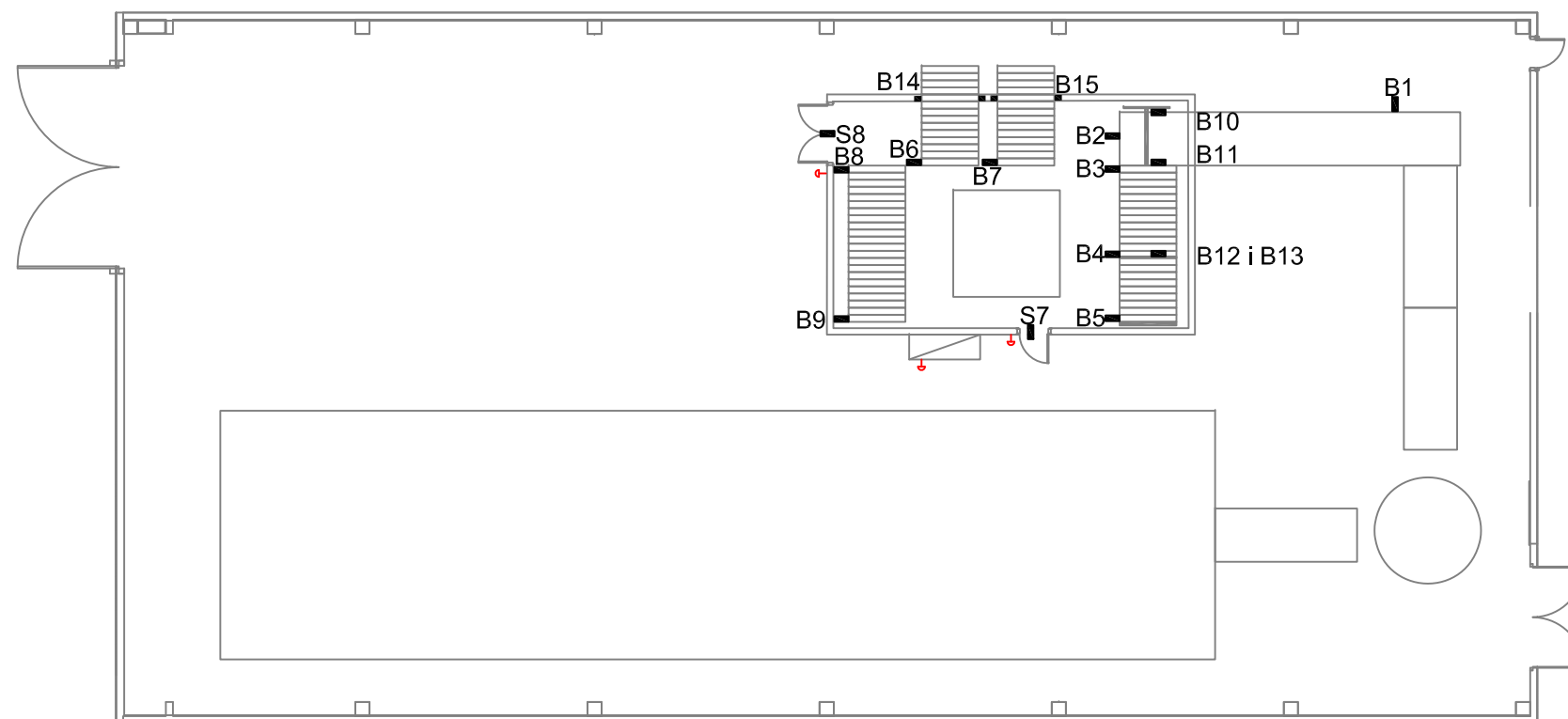

Símbol	Descripció
⚡	Polsador emergència
■	Sensor
▪ ▪	Barrera fotoelèctrica

	Data	Nom	Signatura	
Dibuixat	04/09/23	G. Falgueras		
Comprovat	04/09/23	G. Falgueras		
Escala	UBICACIÓ SENSORS			Nº plànol: 2
1:200				Sustitueix a:
				Especialitat: GEEIA

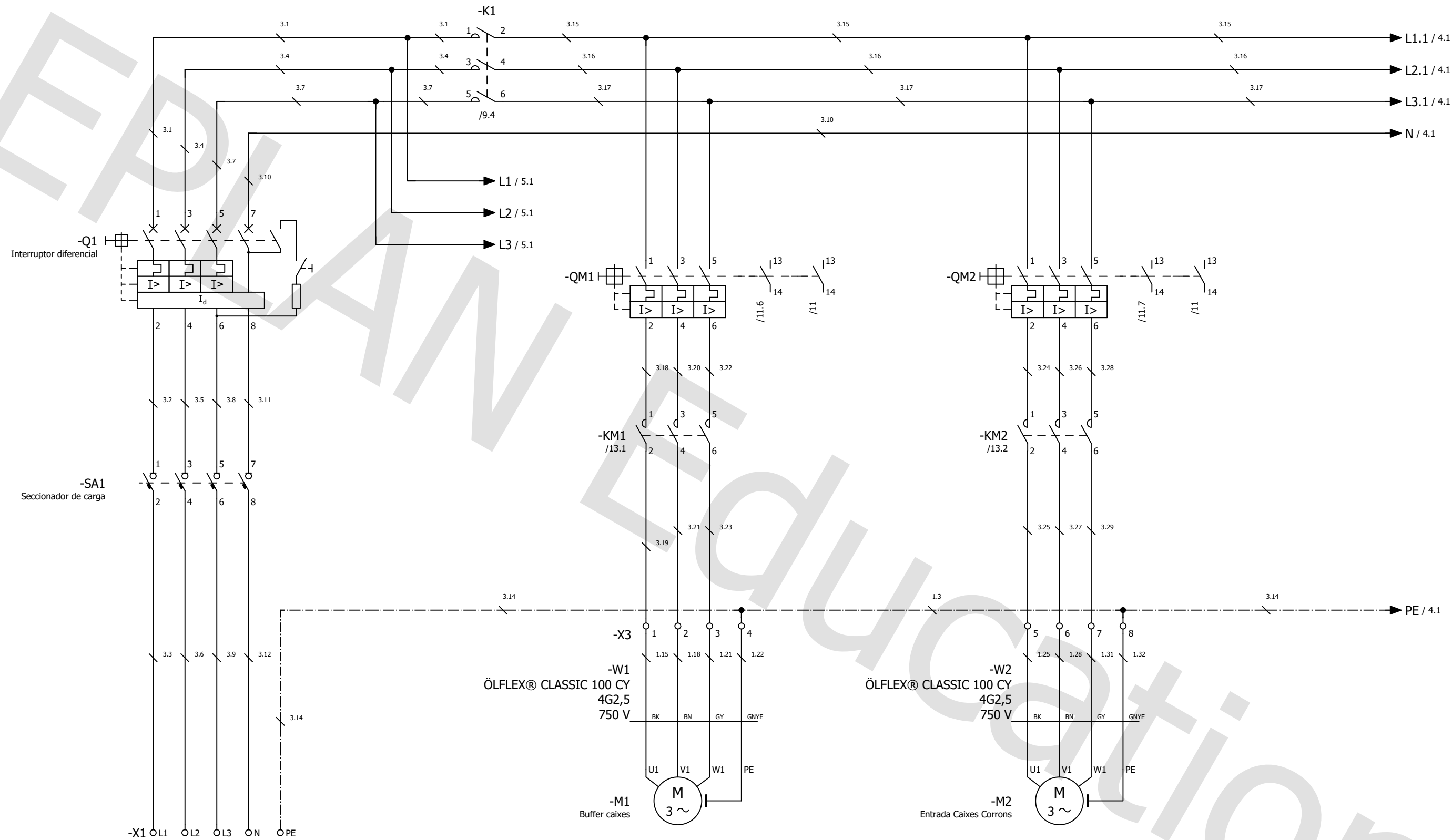

	Data	Nom	Signatura	
Dibuixat	25/08/23	G. Falgueras		
Comprovat	25/08/23	G. Falgueras		
Escala	POTÈNCIA 1			Nº plànol: 3
S.E.				Sustitueix a:
				Especialitat: GEEIA

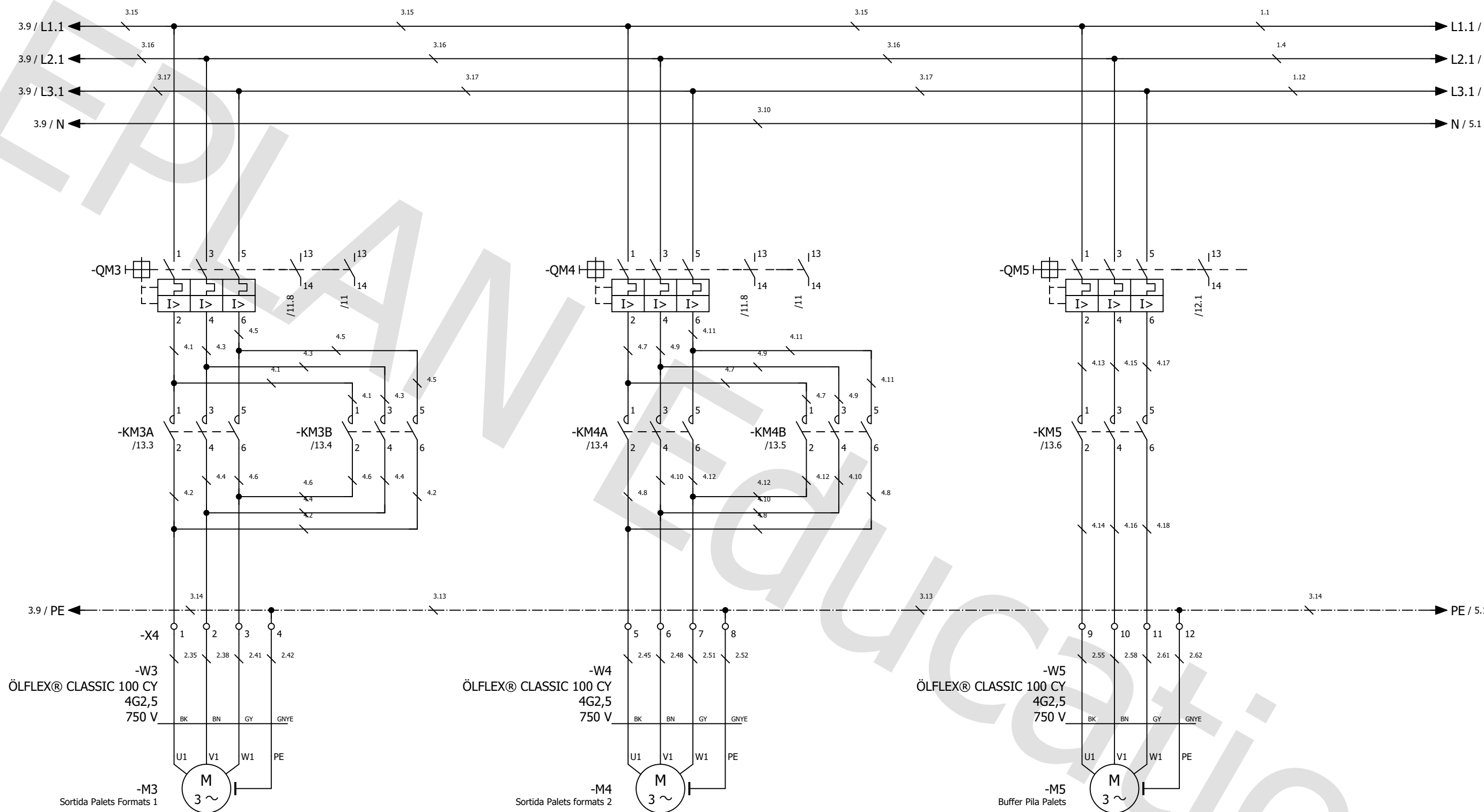

	Data	Nom	Signatura	
Dibuixat	25/08/23	G. Falgueras		
Comprovat	25/08/23	G. Falgueras		
Escala S.E.	POTÈNCIA 2			Nº plànol: 4 Sostitueix a: Especialitat: GEEIA

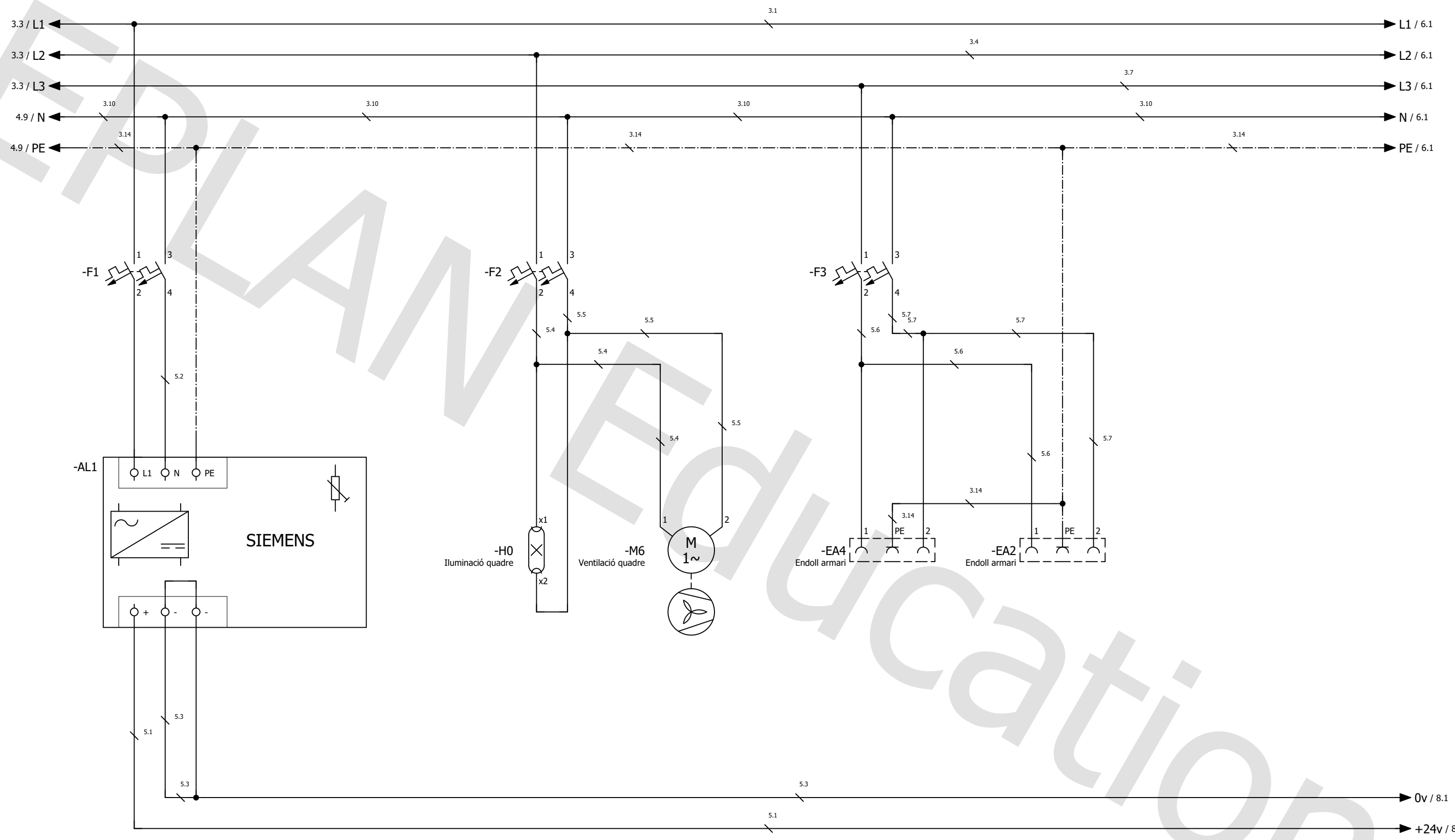

	Data	Nom	Signatura	
Dibuixat	25/08/23	G. Falgueras		
Comprovat	25/08/23	G. Falgueras		
Escala S.E.	POTÈNCIA 3			Nº plànol: 5 Sostitueix a: Especialitat: GEEIA

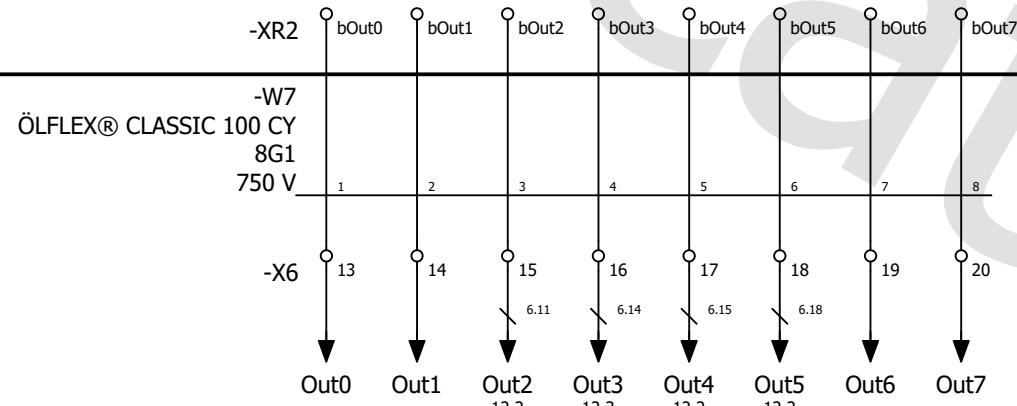
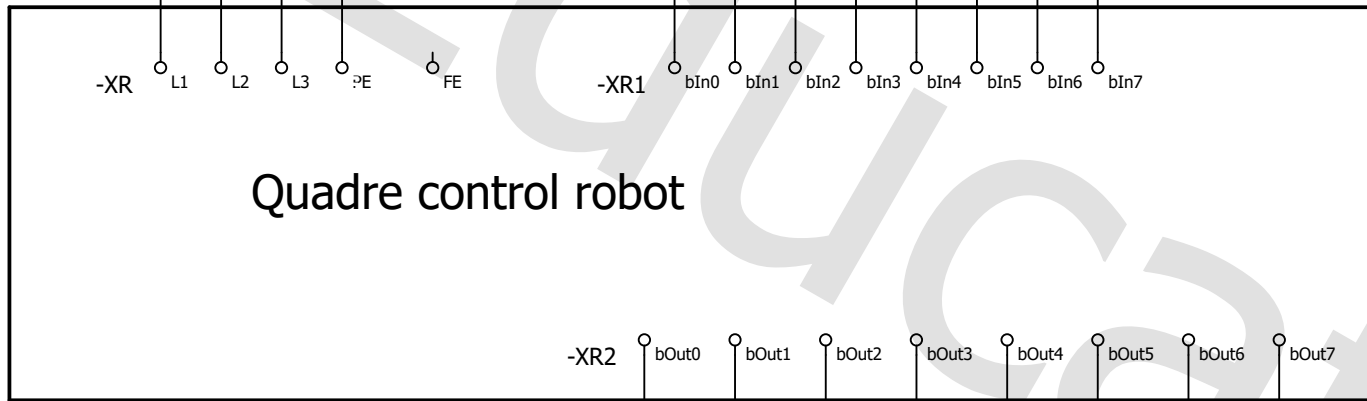
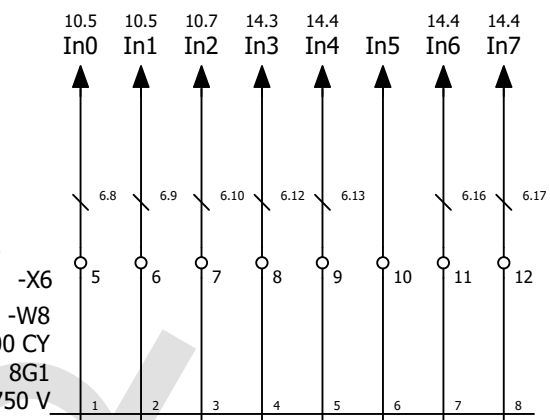
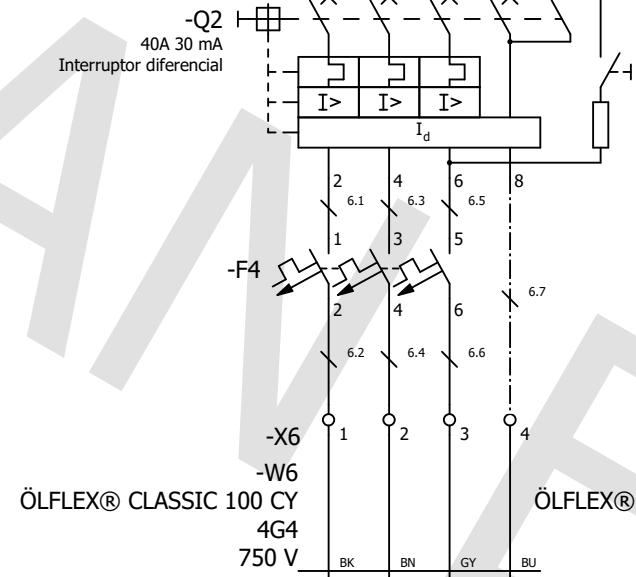
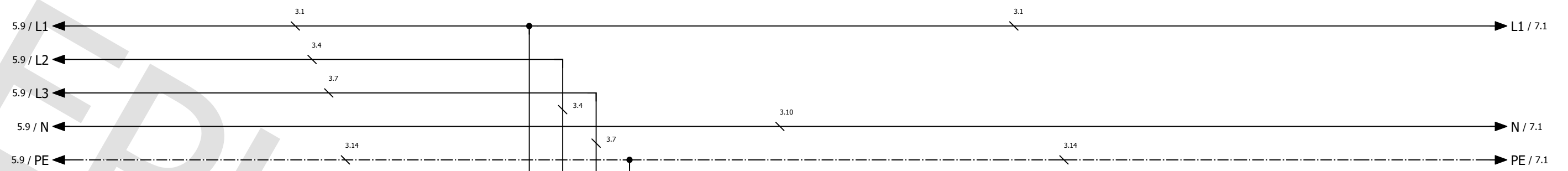

	Data	Nom	Signatura
Dibuixat	25/08/23	G. Falgueras	
Comprovat	25/08/23	G. Falgueras	
Escola	POTÈNCIA ROBOT		Nº plànol: 6
S.E.			Sustitueix a:
			Especialitat: GEEIA



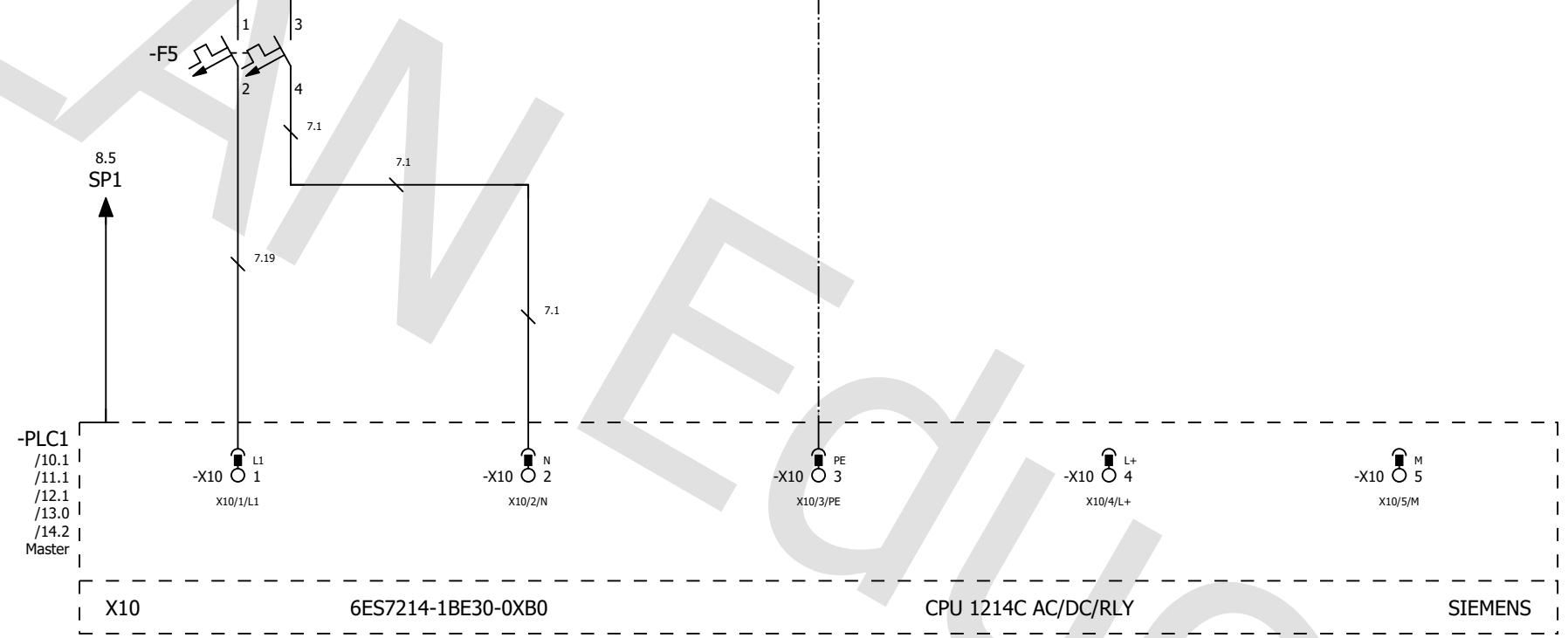
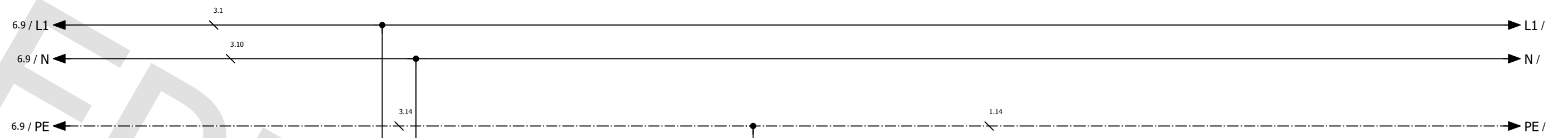

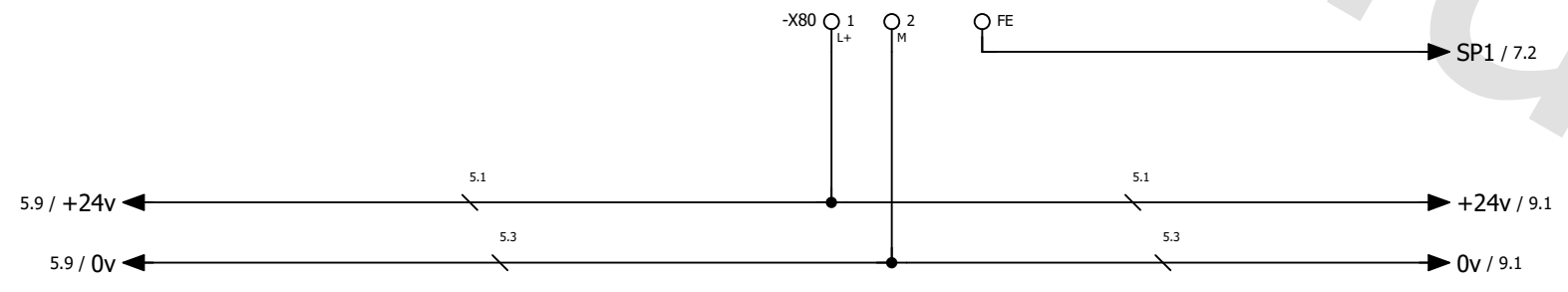
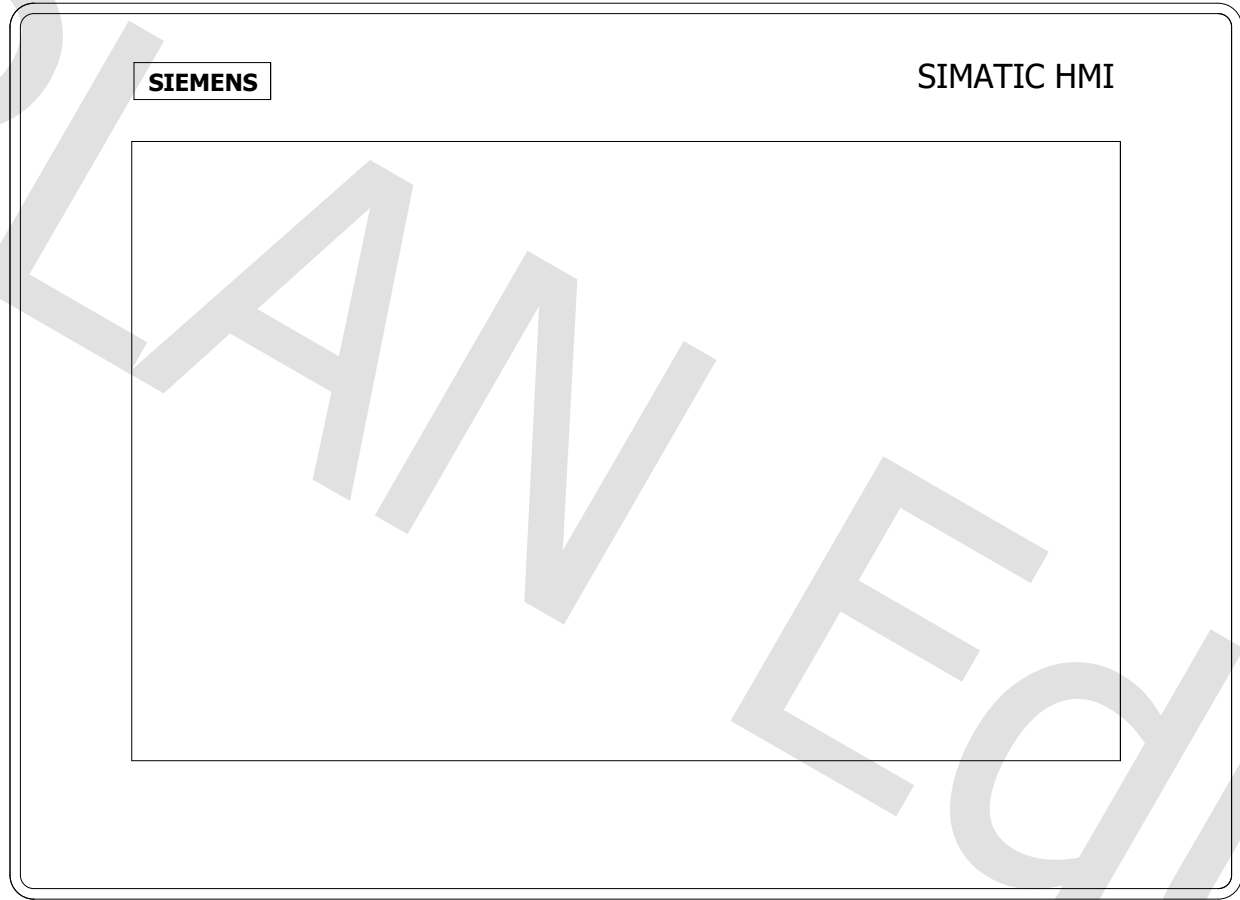

	Data	Nom	Signatura	
Dibuixat	25/08/23	G. Falgueras		
Comprovat	25/08/23	G. Falgueras		
Escala S.E.	PLC ALIMENTACIÓ			Nº plànol: 7 Sostitueix a: Especialitat: GEEIA

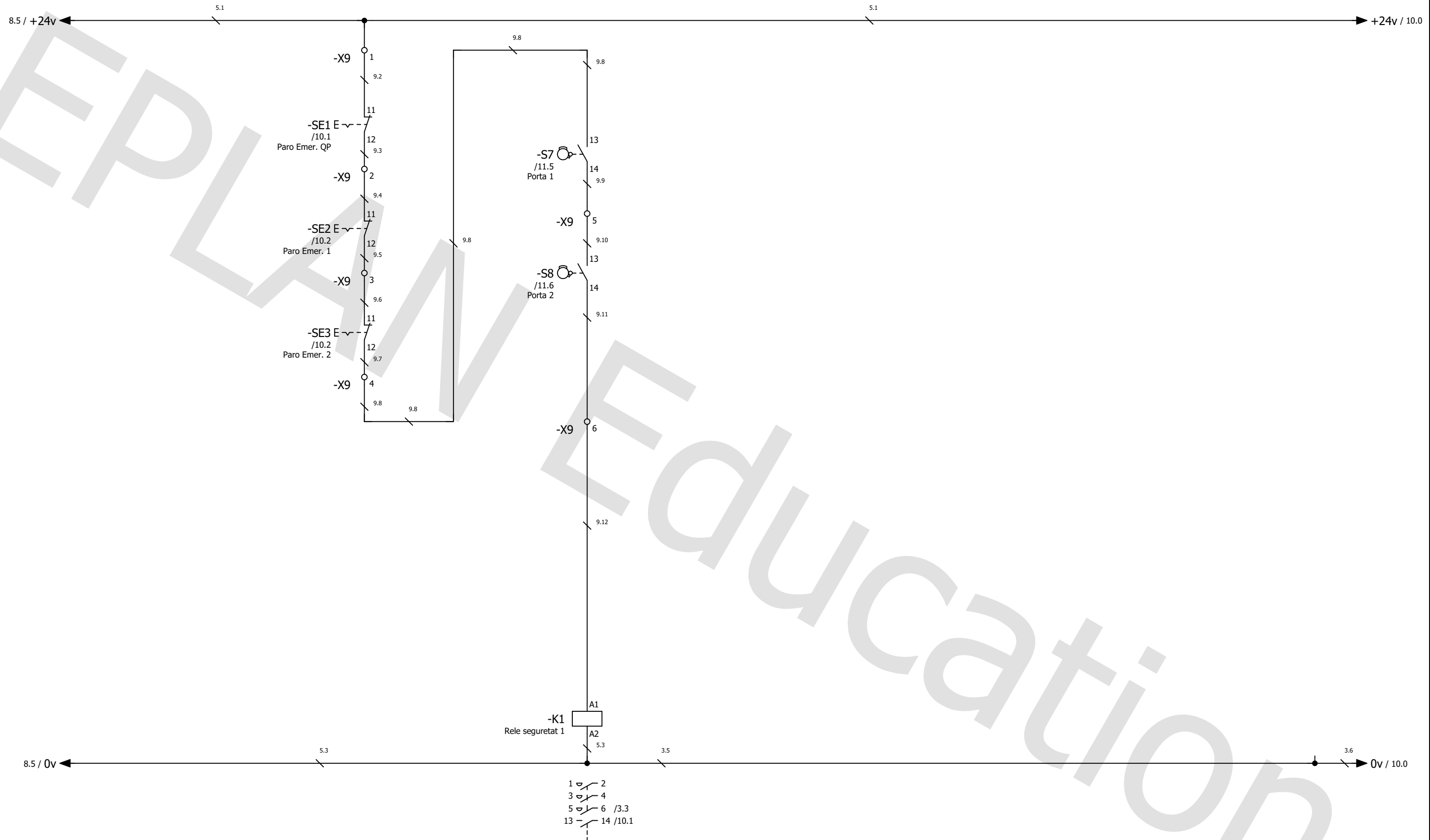

	Data	Nom	Signatura	
Dibuixat	25/08/23	G. Falgueras		
Comprovat	25/08/23	G. Falgueras		
Escala S.E.	HMI ALIMENTACIÓ			Nº plànol: 8 Sostitueix a: Especialitat: GEEIA



	Data	Nom	Signatura	
Dibuixat	25/08/23	G. Falgueras		
Comprovat	25/08/23	G. Falgueras		
Escala S.E.	SEGURETAT			Nº plànol: 9
				Sustitueix a:
				Especialitat: GEEIA

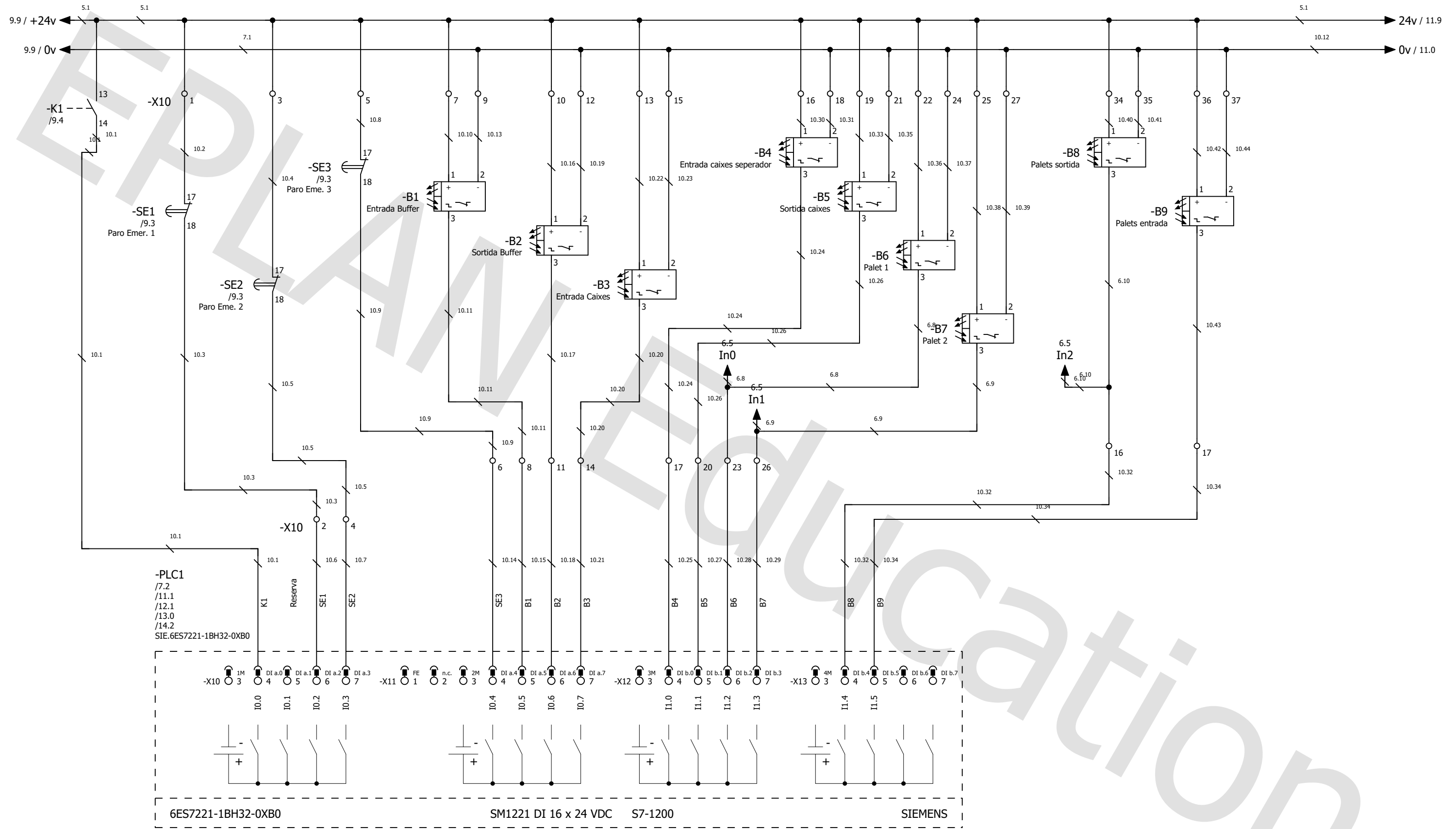

	Data	Nom	Signatura
Dibuixat	25/08/23	G. Falgueras	
Comprovat	25/08/23	G. Falgueras	
Escala	S.E.		Nº plànol: 10
	PLC ENTRADES 1		Sustitueix a:
			Especialitat: GEEIA



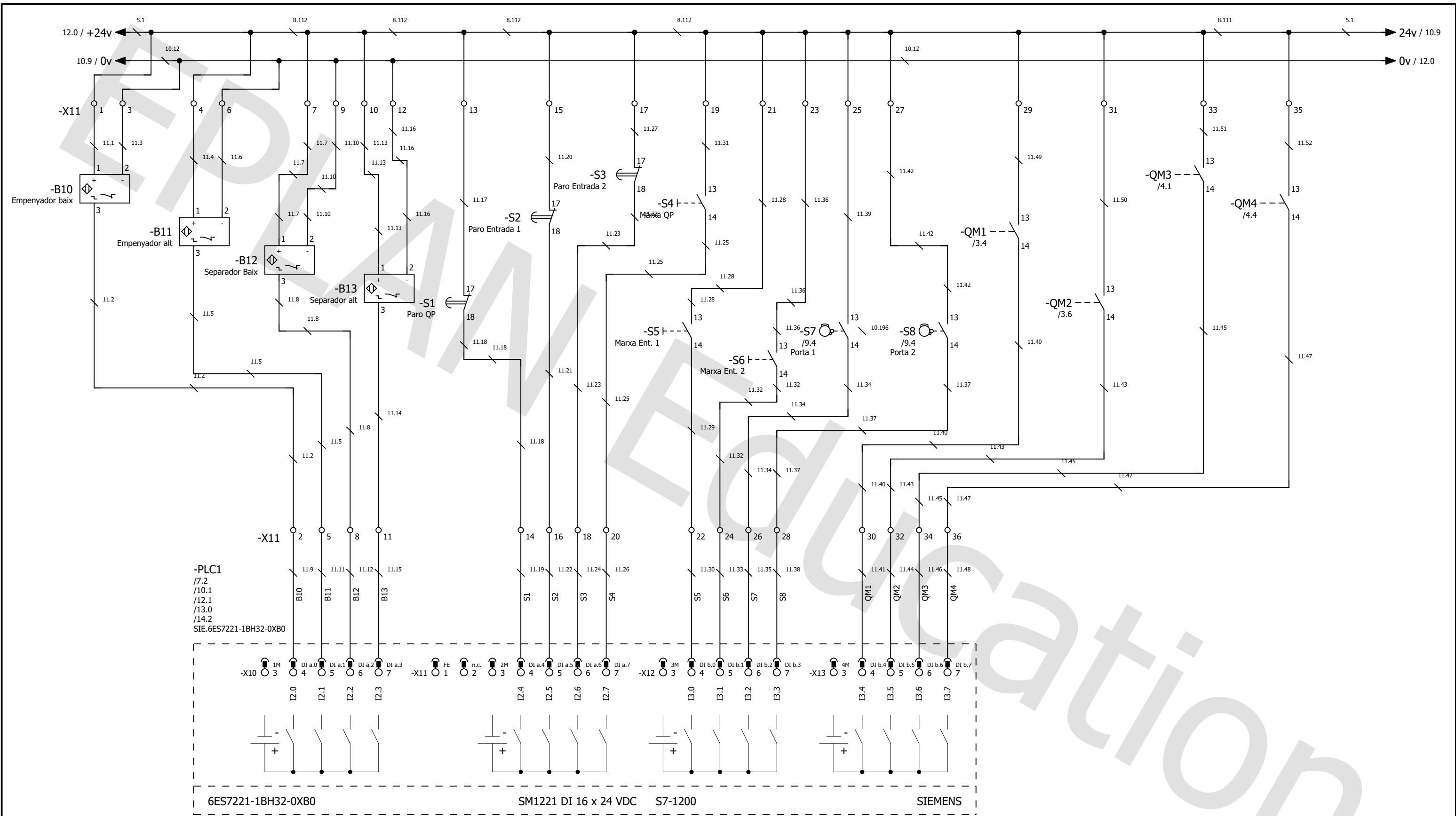

	Data	Nom	Signatura	
Dibuixat	25/08/23	G. Falgueras		
Comprovat	25/08/23	G. Falgueras		
Escala S.E.	PLC ENTRADES 2			Nº plànol: 11 Sostitueix a: Especialitat: GEEIA

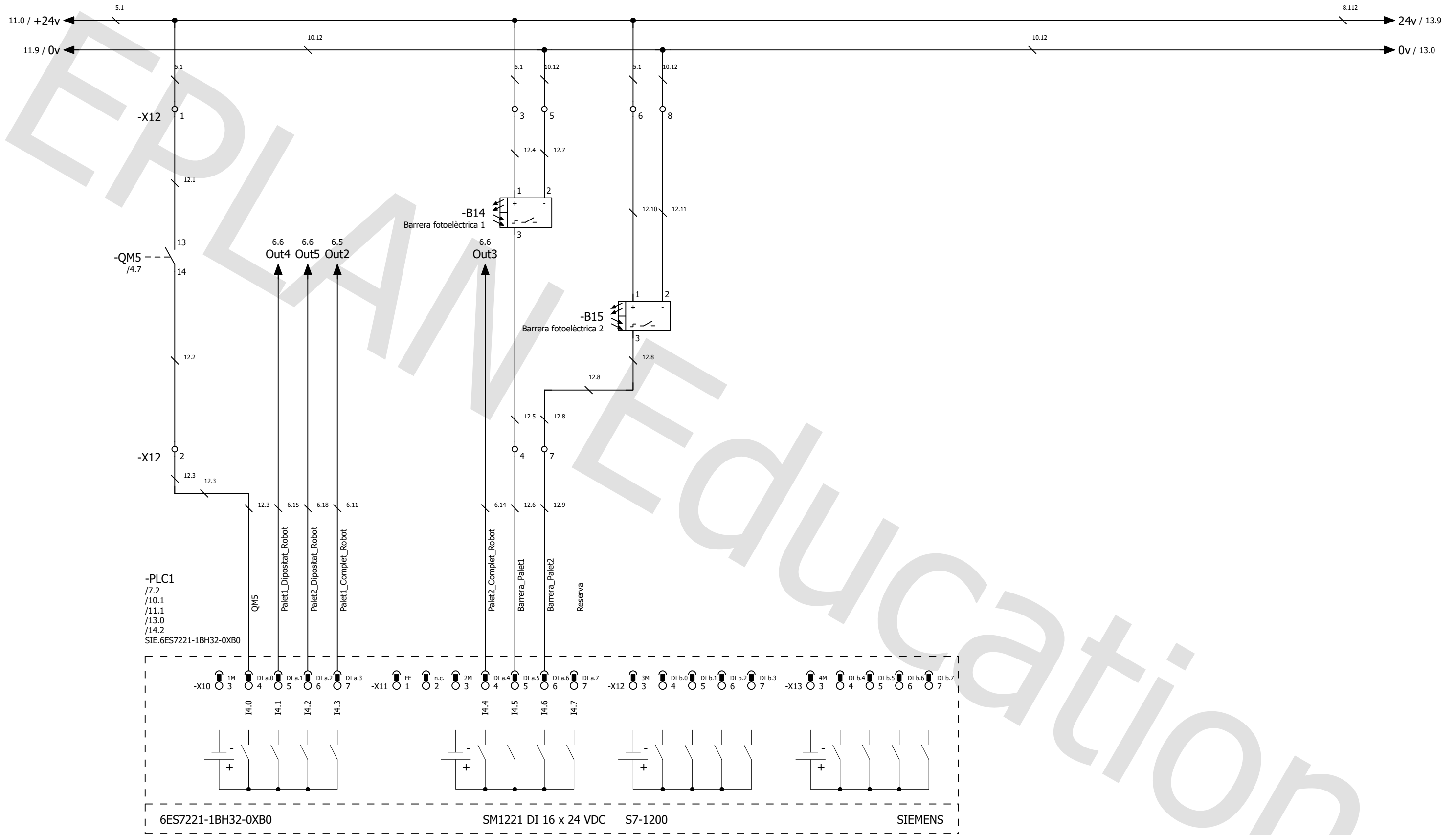

	Data	Nom	Signatura
Dibuixat	25/08/23	G. Falgueras	
Comprovat	25/08/23	G. Falgueras	
Escala	S.E.		Nº plànol: 12
	PLC ENTRADES 3		Sustitueix a:
			Especialitat: GEEIA



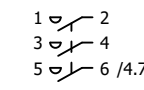
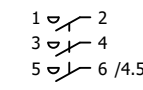
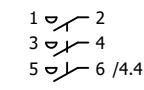
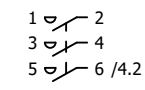
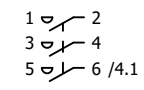
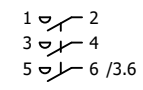
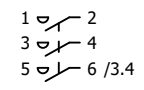
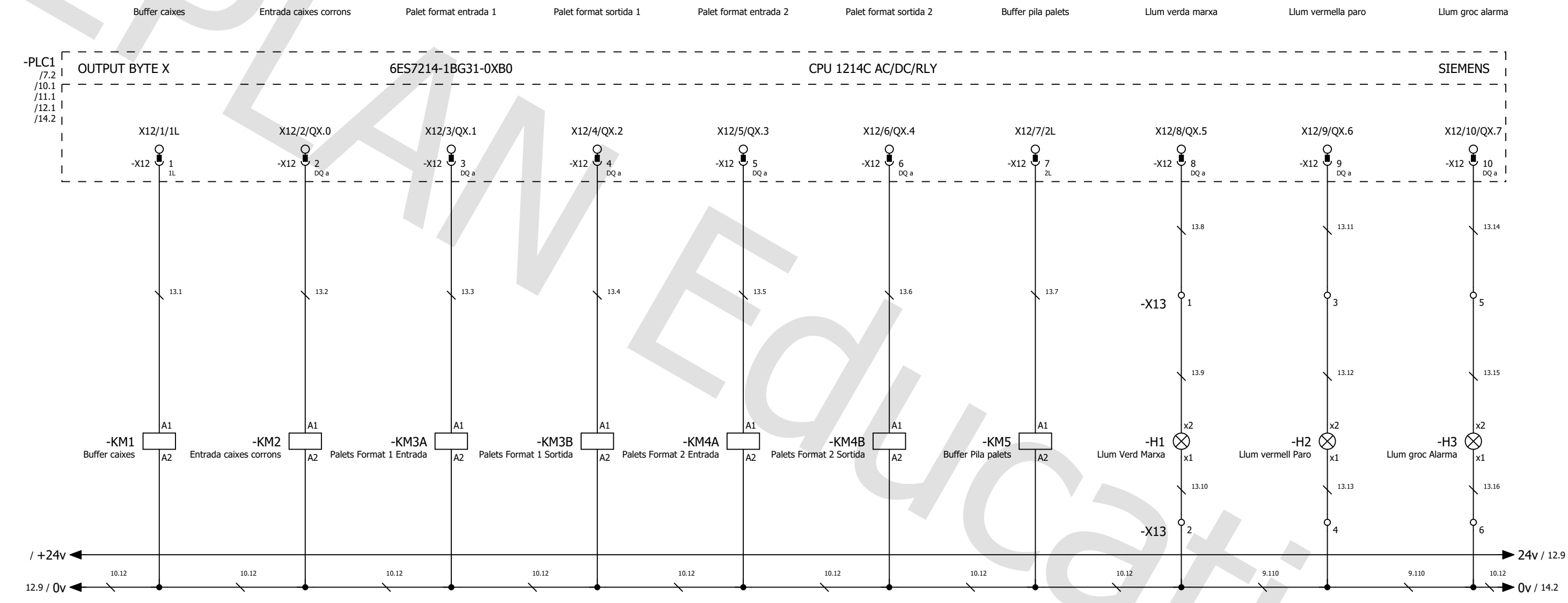

	Data	Nom	Signatura	
Dibuixat	25/08/23	G. Falgueras		
Comprovat	25/08/23	G. Falgueras		
Escala S.E.	PLC SORTIDES 1			Nº plànol: 13 Sustitueix a: Especialitat: GEEIA

-PLC1
/7.2
/10.1
/11.1
/12.1
/13.0
SIE.6ES7222-1BH32-1XB0

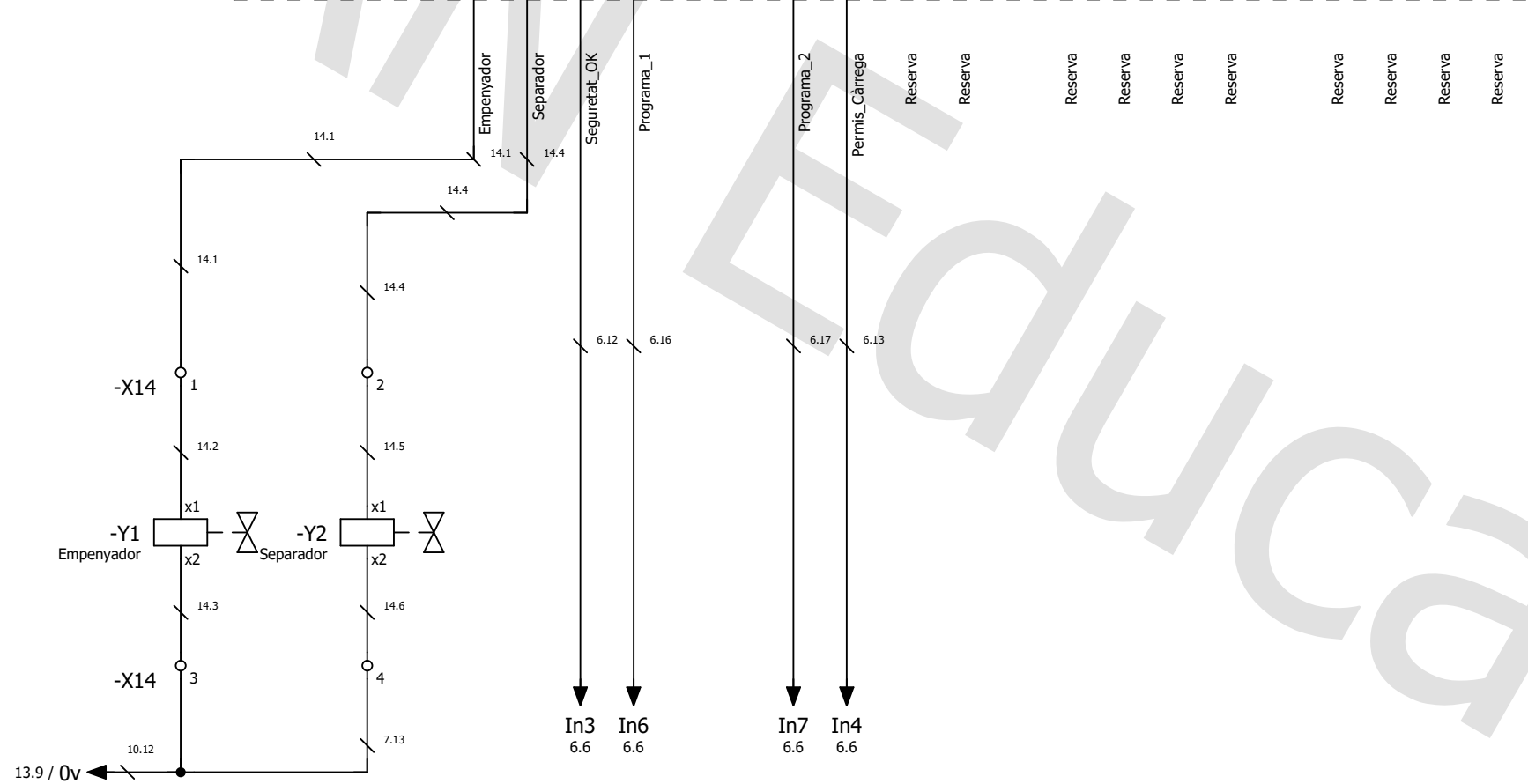
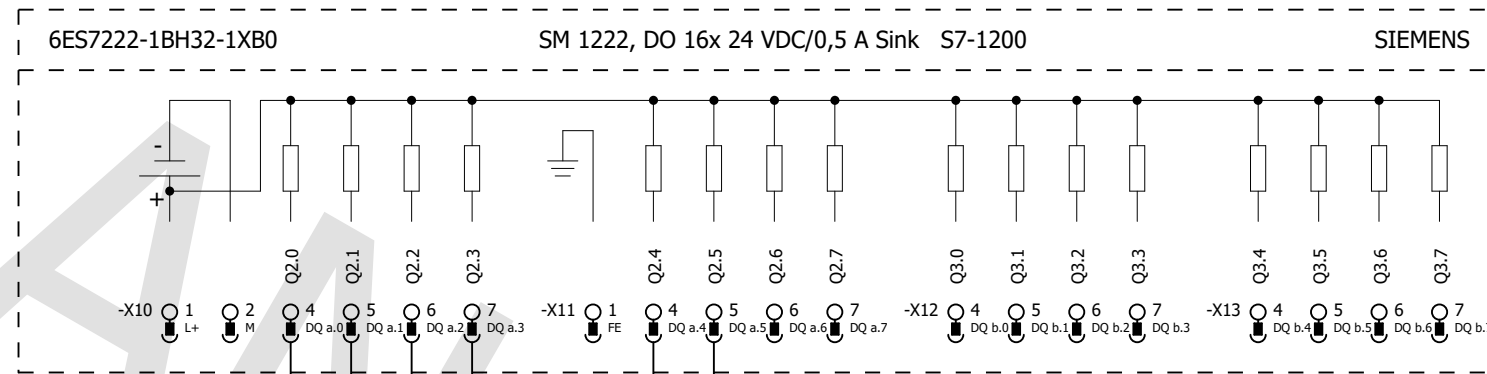

	Data	Nom	Signatura	
Dibuixat	25/08/23	G. Falgueras		
Comprovat	25/08/23	G. Falgueras		
Escala S.E.	PLC SORTIDES 2			Nº plànol: 14 Sostitueix a: Especialitat: GEEIA

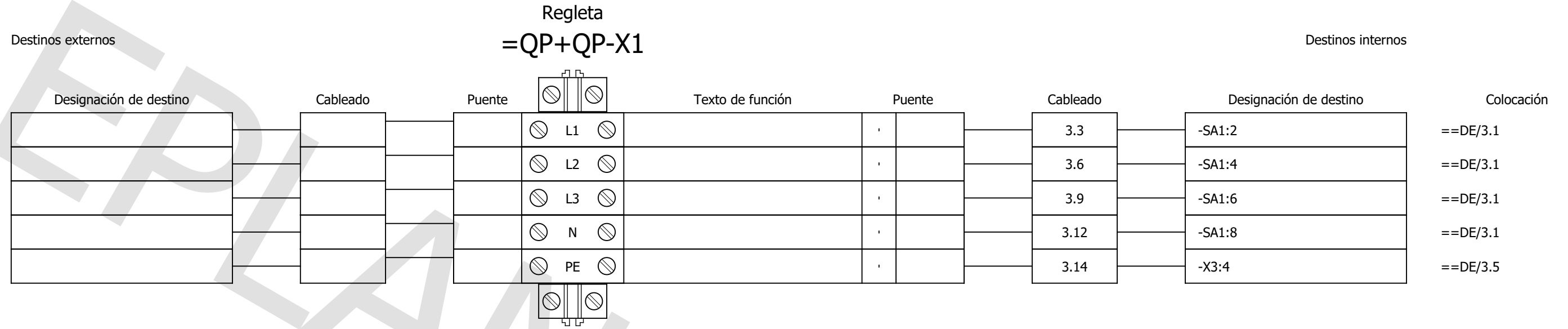

	Data	Nom	Signatura	
Dibuixat	25/08/23	G. Falgueras		
Comprovat	25/08/23	G. Falgueras		
Escala	BORNS =QP+QP-X1			Nº plànol: 15
S.E.				Sustitueix a:
				Especialitat: GEEIA

Destinos externos

Regleta
=QP+QP-X3

Destinos internos

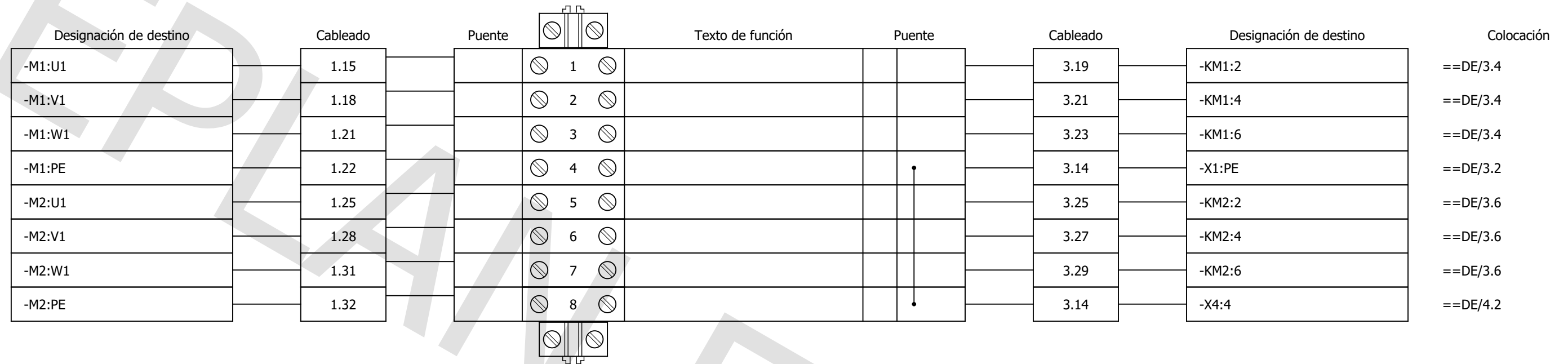

	Data	Nom	Signatura	
Dibuixat	25/08/23	G. Falgueras		
Comprovat	25/08/23	G. Falgueras		
Escala	BORNS =QP+QP-X3			Nº plànol: 16
S.E.				Sustitueix a:
				Especialitat: GEEIA

Destinos externos

Regleta
=QP+QP-X4

Destinos internos

Designación de destino	Cableado	Puente	Texto de función	Puente	Cableado	Designación de destino	Colocación
-M3:U1	2.35	1			4.2	-KM3A:2	==DE/4.1
					4.2	-KM3B:6	==DE/4.2
-M3:V1	2.38	2			4.4	-KM3A:4	==DE/4.1
					4.4	-KM3B:4	==DE/4.2
-M3:W1	2.41	3			4.6	-KM3A:6	==DE/4.1
					4.6	-KM3B:2	==DE/4.2
-M3:PE	2.42	4			3.14	-X3:8	==DE/3.7
-M4:U1	2.45	5			4.8	-KM4A:2	==DE/4.4
					4.8	-KM4B:6	==DE/4.5
-M4:V1	2.48	6			4.10	-KM4A:4	==DE/4.4
					4.10	-KM4B:4	==DE/4.5
-M4:W1	2.51	7			4.12	-KM4A:6	==DE/4.4
					4.12	-KM4B:2	==DE/4.5
-M4:PE	2.52	8					
-M5:U1	2.55	9			4.14	-KM5:2	==DE/4.7
-M5:V1	2.58	10			4.16	-KM5:4	==DE/4.7
-M5:W1	2.61	11			4.18	-KM5:6	==DE/4.7
-M5:PE	2.62	12			3.14	-AL1:PE	==DE/5.2

	Data	Nom	Signatura	
Dibuixat	25/08/23	G. Falgueras		
Comprovat	25/08/23	G. Falgueras		
Escala	S.E.			Nº plànol: 17
	BORNS =QP+QP-X4			Sustitueix a:
				Especialitat: GEEIA

Regleta
=QP+QP-X6

Destinos externos

Destinos internos

Designación de destino	Cableado	Puente	Texto de función	Puente	Cableado	Designación de destino	Colocación
-F4:2	6.2	1				-XR:L1	==DE/6.3
-F4:4	6.4	2				-XR:L2	==DE/6.4
-F4:6	6.6	3				-XR:L3	==DE/6.4
-Q2:8	6.7	4				-XR:PE	==DE/6.4
23	6.8	5				-XR1:bIn0	==DE/6.5
26	6.9	6				-XR1:bIn1	==DE/6.5
16	6.10	7				-XR1:bIn2	==DE/6.5
-PLC1:-X10:6	6.12	8				-XR1:bIn3	==DE/6.6
-PLC1:-X11:5	6.13	9				-XR1:bIn4	==DE/6.6
		10				-XR1:bIn5	==DE/6.6
-PLC1:-X10:7	6.16	11				-XR1:bIn6	==DE/6.6
-PLC1:-X11:4	6.17	12				-XR1:bIn7	==DE/6.6
-XR2:bOut0		13					
-XR2:bOut1		14					
-XR2:bOut2		15			6.11	-PLC1:-X10:7	==DE/12.2
-XR2:bOut3		16			6.14	-PLC1:-X11:4	==DE/12.3
-XR2:bOut4		17			6.15	-PLC1:-X10:5	==DE/12.2
-XR2:bOut5		18			6.18	-PLC1:-X10:6	==DE/12.2
-XR2:bOut6		19					
-XR2:bOut7		20					

	Data	Nom	Signatura	
Dibuixat	25/08/23	G. Falgueras		
Comprovat	25/08/23	G. Falgueras		
Escala	BORNS =QP+QP-X6			Nº plànol: 18
S.E.				Sustitueix a:
				Especialitat: GEEIA

Regleta
=QP+QP-X9

Destinos externos

Destinos internos





	Data	Nom	Signatura	
Dibuixat	25/08/23	G. Falgueras		
Comprovat	25/08/23	G. Falgueras		
Escala	BORNS =QP+QP-X9			Nº plànol: 19
S.E.				Sustitueix a:
				Especialitat: GEEIA

**Regleta
=QP+QP-X10**

Destinos externos

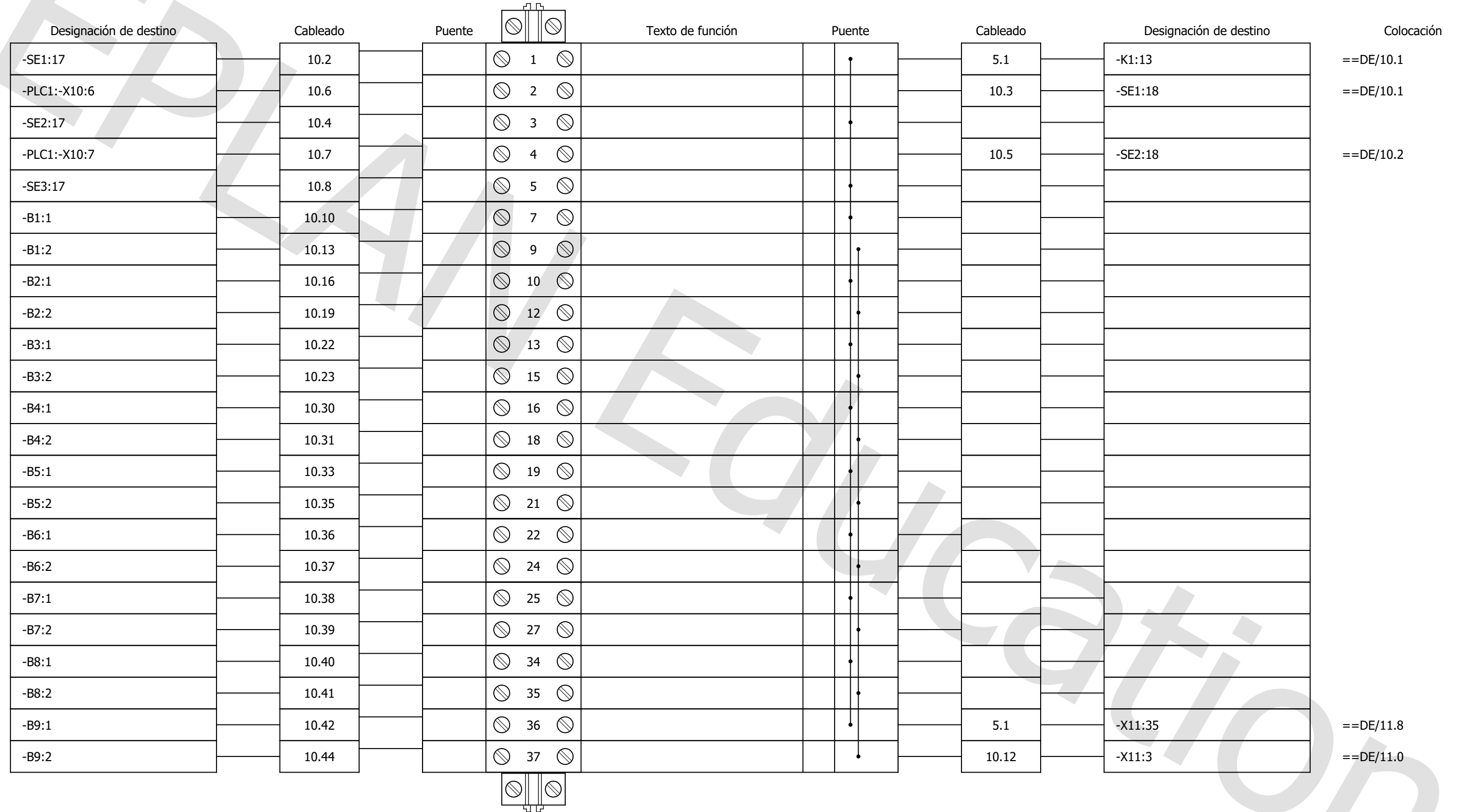
Destinos internos



	Data	Nom	Signatura	
Dibuixat	25/08/23	G. Falgueras		
Comprovat	25/08/23	G. Falgueras		
Escala	<p align="center">BORNS =QP+QP-X10</p>			Nº plànol: 20
S.E.				Sustitueix a:
				Especialitat: GEEIA

Regleta
=QP+QP-X11

Destinos externos

Destinos internos

Designación de destino	Cableado	Puente	Texto de función	Puente	Cableado	Designación de destino	Colocación
-B10:1	11.1	1			5.1	-X12:1	==DE/12.1
-PLC1:-X10:4	11.9	2			11.2	-B10:3	==DE/11.0
-B10:2	11.3	3			10.12	-X10:37	==DE/10.8
-B11:1	11.4	4					
-PLC1:-X10:5	11.11	5			11.5	-B11:3	==DE/11.1
-B11:2	11.6	6					
-B12:1	11.7	7					
-PLC1:-X10:6	11.12	8			11.8	-B12:3	==DE/11.2
-B12:2	11.10	9					
-B13:1	11.13	10					
-PLC1:-X10:7	11.15	11			11.14	-B13:3	==DE/11.2
-B13:2	11.16	12			10.12	-X12:5	==DE/12.4
-S1:17	11.17	13					
-PLC1:-X11:4	11.19	14			11.18	-S1:18	==DE/11.3
-S2:17	11.20	15					
-PLC1:-X11:5	11.22	16			11.21	-S2:18	==DE/11.3
-S3:17	11.27	17					
-PLC1:-X11:6	11.24	18			11.23	-S3:18	==DE/11.4
-S4:13	11.31	19					
-PLC1:-X11:7	11.26	20			11.25	-S4:14	==DE/11.4
-S5:13	11.28	21					
-PLC1:-X12:4	11.30	22			11.29	-S5:14	==DE/11.4
-S6:13	11.36	23					
-PLC1:-X12:5	11.33	24			11.32	-S6:14	==DE/11.5
-S7:13	11.39	25					

	Data	Nom	Signatura	
Dibuixat	25/08/23	G. Falgueras		
Comprovat	25/08/23	G. Falgueras		
Escala	<p align="center">BORNS =QP+QP-X11</p>			Nº plànol: 21
S.E.				Sustitueix a:
				Especialitat: GEEIA

Regleta
=QP+QP-X11

Destinos externos

Destinos internos

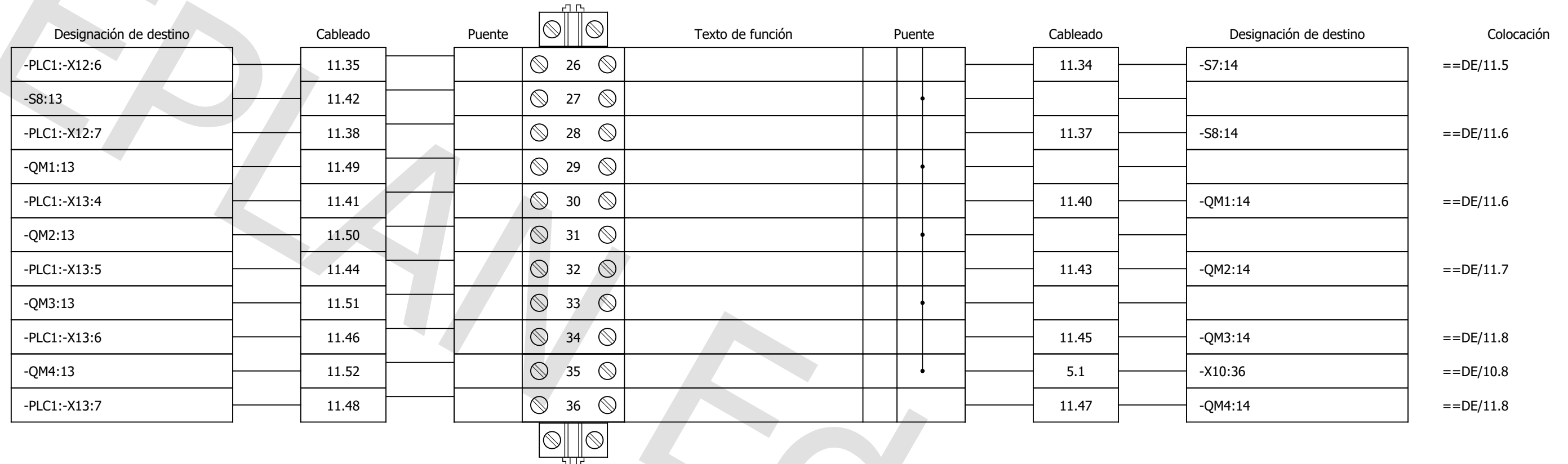

	Data	Nom	Signatura	
Dibuixat	25/08/23	G. Falgueras		
Comprovat	25/08/23	G. Falgueras		
Escala	BORNS =QP+QP-X11			Nº plànol: 22
S.E.				Sustitueix a:
				Especialitat: GEEIA

Regleta
=QP+QP-X12

Destinos externos

Destinos internos

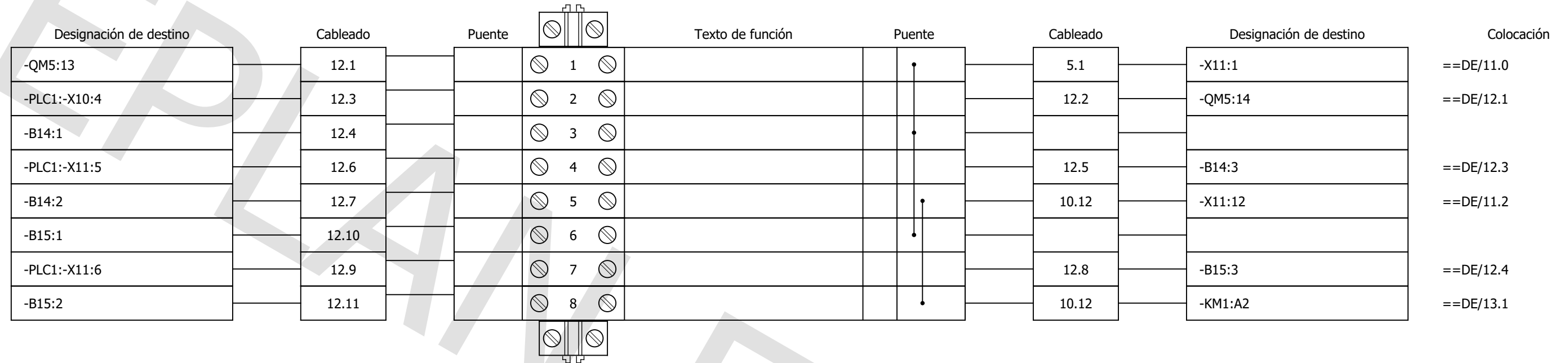

	Data	Nom	Signatura	
Dibuixat	25/08/23	G. Falgueras		
Comprovat	25/08/23	G. Falgueras		
Escala	BORNS =QP+QP-X12			Nº plànol: 23
S.E.				Sustitueix a:
				Especialitat: GEEIA

Regleta
=QP+QP-X13

Destinos externos

Destinos internos

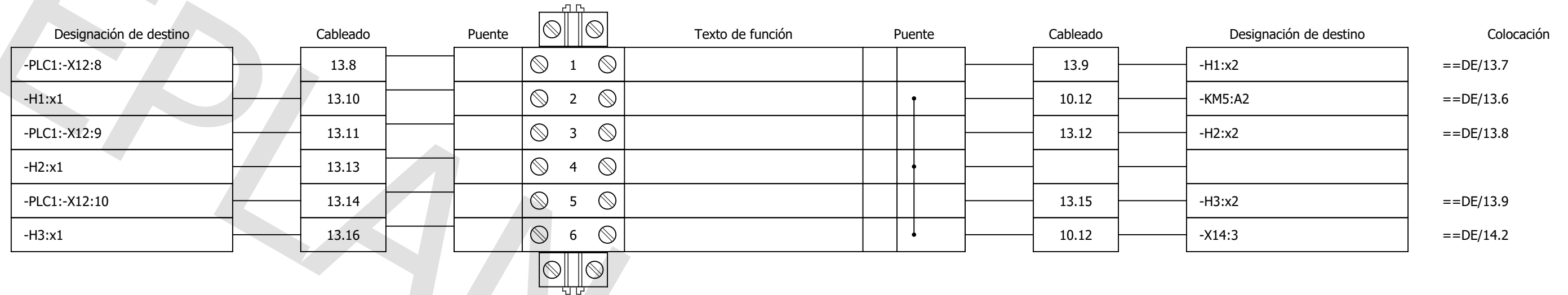

	Data	Nom	Signatura	
Dibuixat	25/08/23	G. Falgueras		
Comprovat	25/08/23	G. Falgueras		
Escala	BORNS =QP+QP-X13			Nº plànol: 24
S.E.				Sustitueix a:
				Especialitat: GEEIA

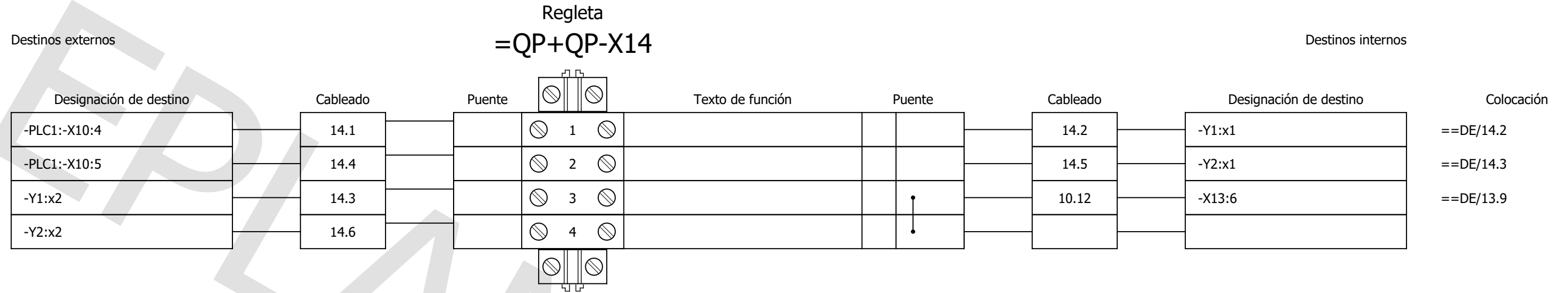

	Data	Nom	Signatura	
Dibuixat	25/08/23	G. Falgueras		
Comprovat	25/08/23	G. Falgueras		
Escala	BORNS =QP+QP-X14			Nº plànol: 25
S.E.				Sustitueix a:
				Especialitat: GEEIA



	Data	Nom	Signatura	
Dibuixat	25/08/23	G. Falgueras		
Comprovat	25/08/23	G. Falgueras		
Escala	BORNS =QP+QP-XR			Nº plànol: 26
S.E.				Sustitueix a:
				Especialitat: GEEIA

Destinos externos

Regleta
=QP+QP-XR1

Destinos internos

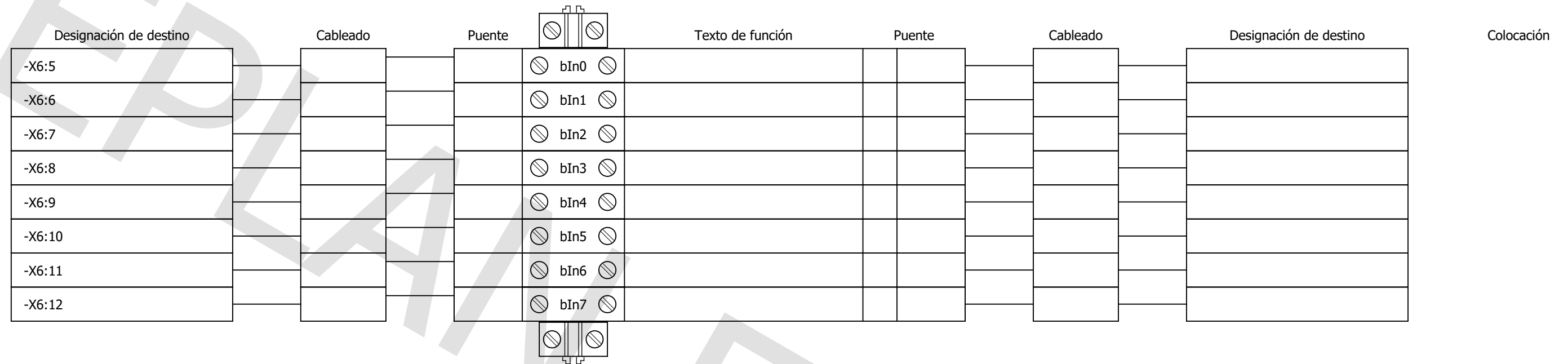

	Data	Nom	Signatura	
Dibuixat	25/08/23	G. Falgueras		
Comprovat	25/08/23	G. Falgueras		
Escala	BORNS =QP+QP-XR1			Nº plànol: 27
S.E.				Sustitueix a:
				Especialitat: GEEIA

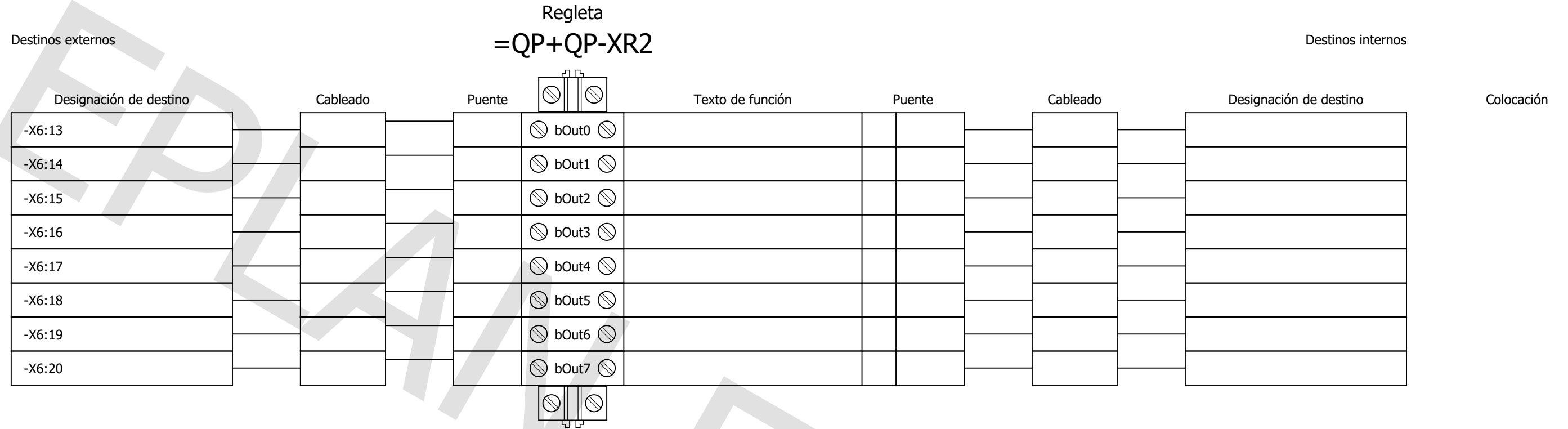

	Data	Nom	Signatura	
Dibuixat	25/08/23	G. Falgueras		
Comprovat	25/08/23	G. Falgueras		
Escala	BORNS =QP+QP-XR2			Nº plànol: 28
S.E.				Sustitueix a:
				Especialitat: GEEIA

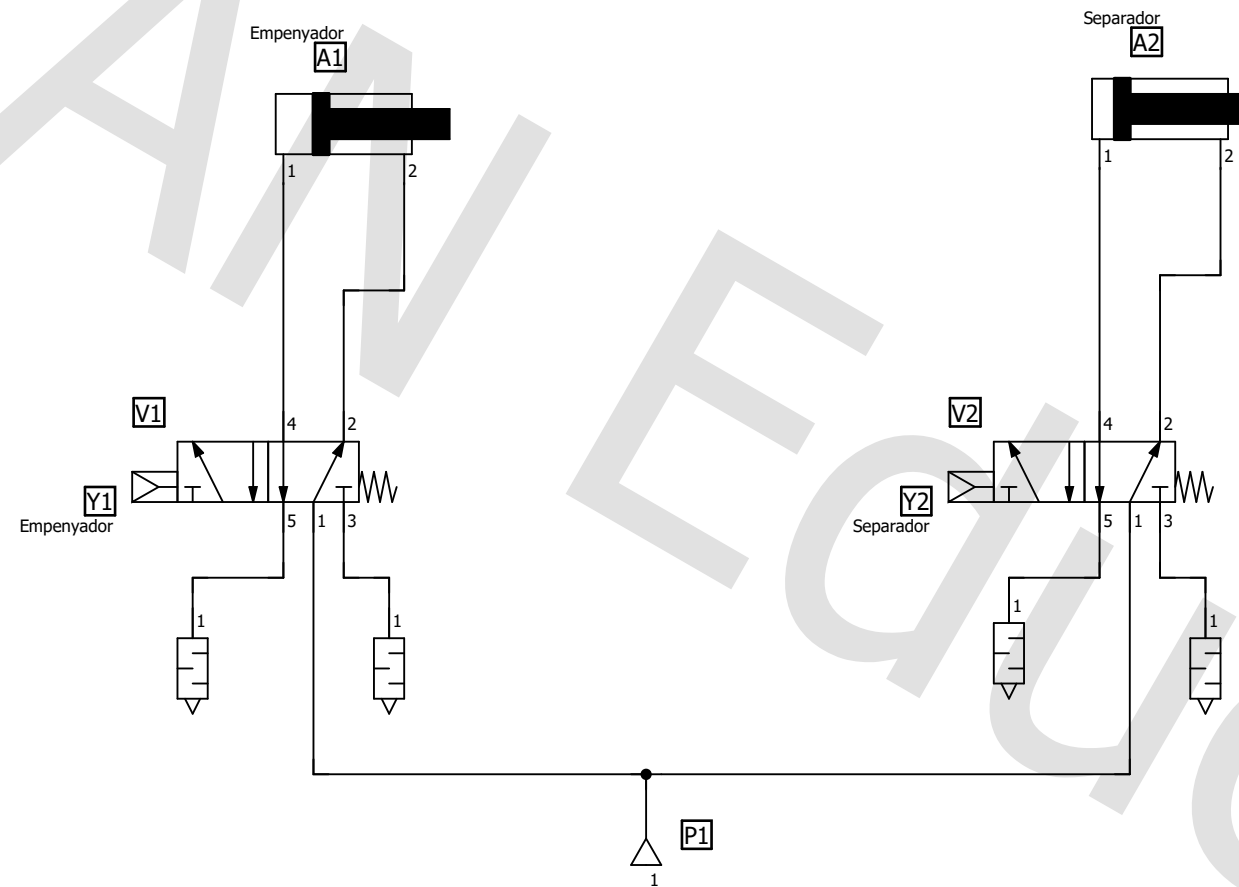

	Data	Nom	Signatura	
Dibuixat	25/08/23	G. Falgueras		
Comprovat	25/08/23	G. Falgueras		
Escala S.E.	PNEUMÀTICA			Nº plànol: 29 Sostitueix a: Especialitat: GEEIA