

IMATGE ULL

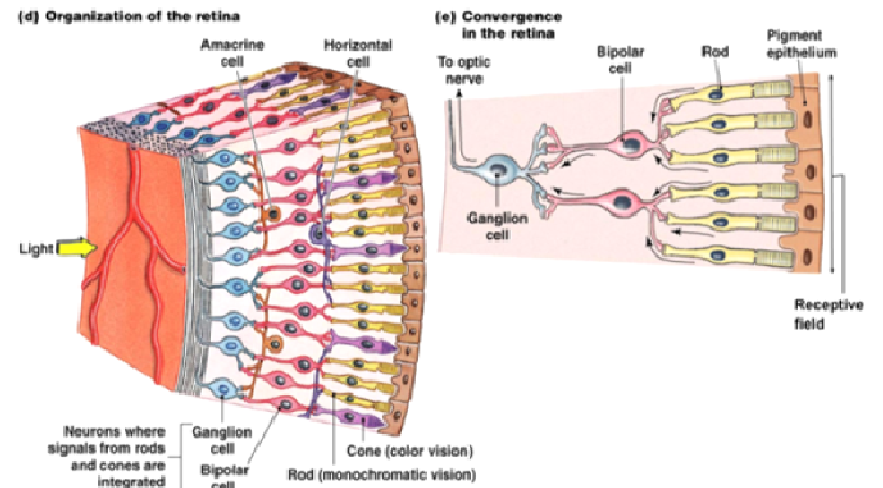

IMATGES TEMA 1 VPC

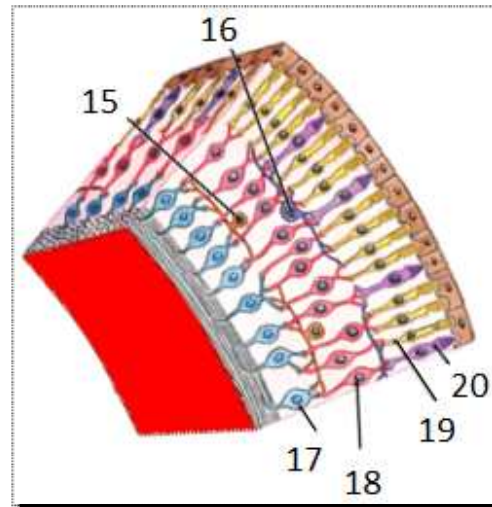
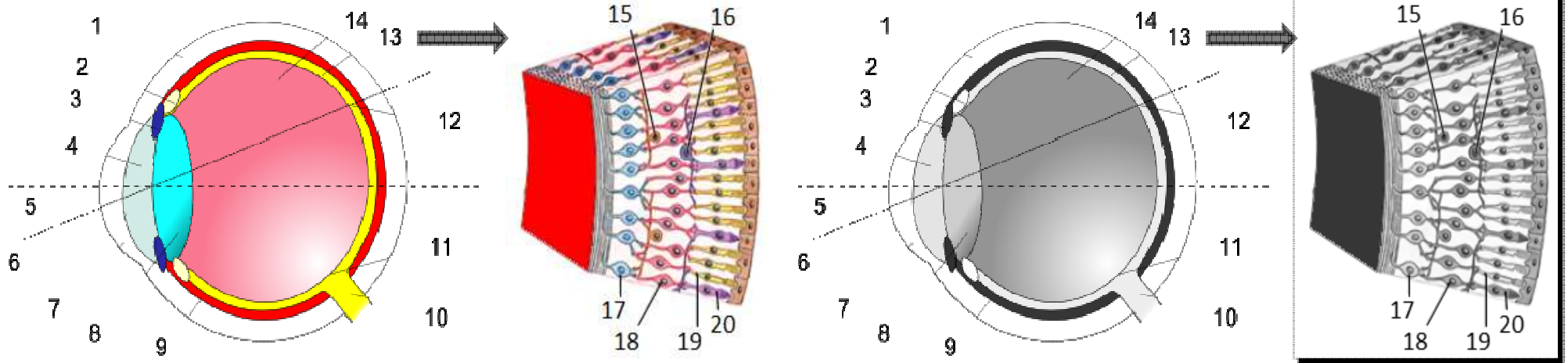
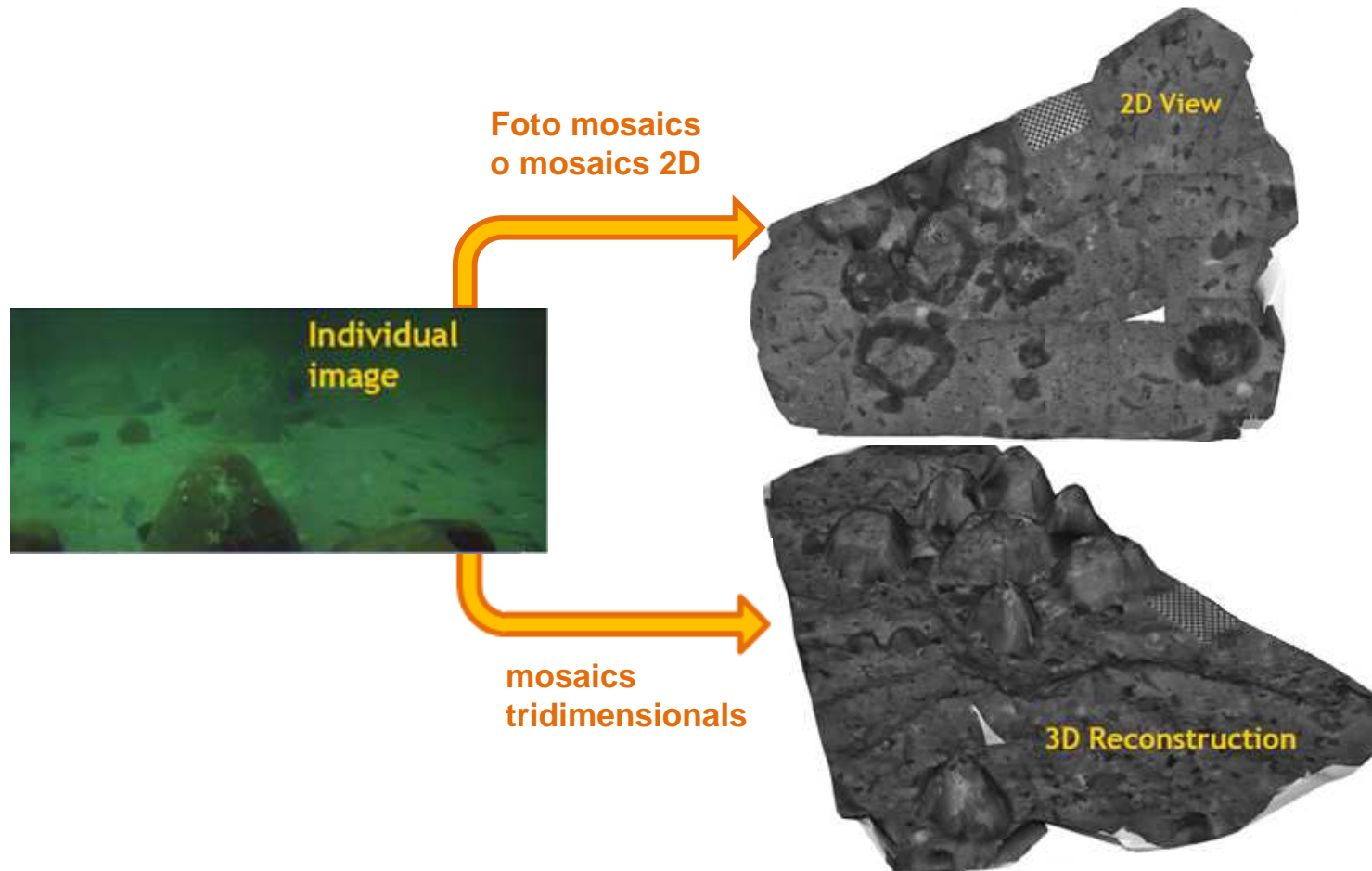

DELS APUNTS TEMA 6 VPC (MODIFICADA)

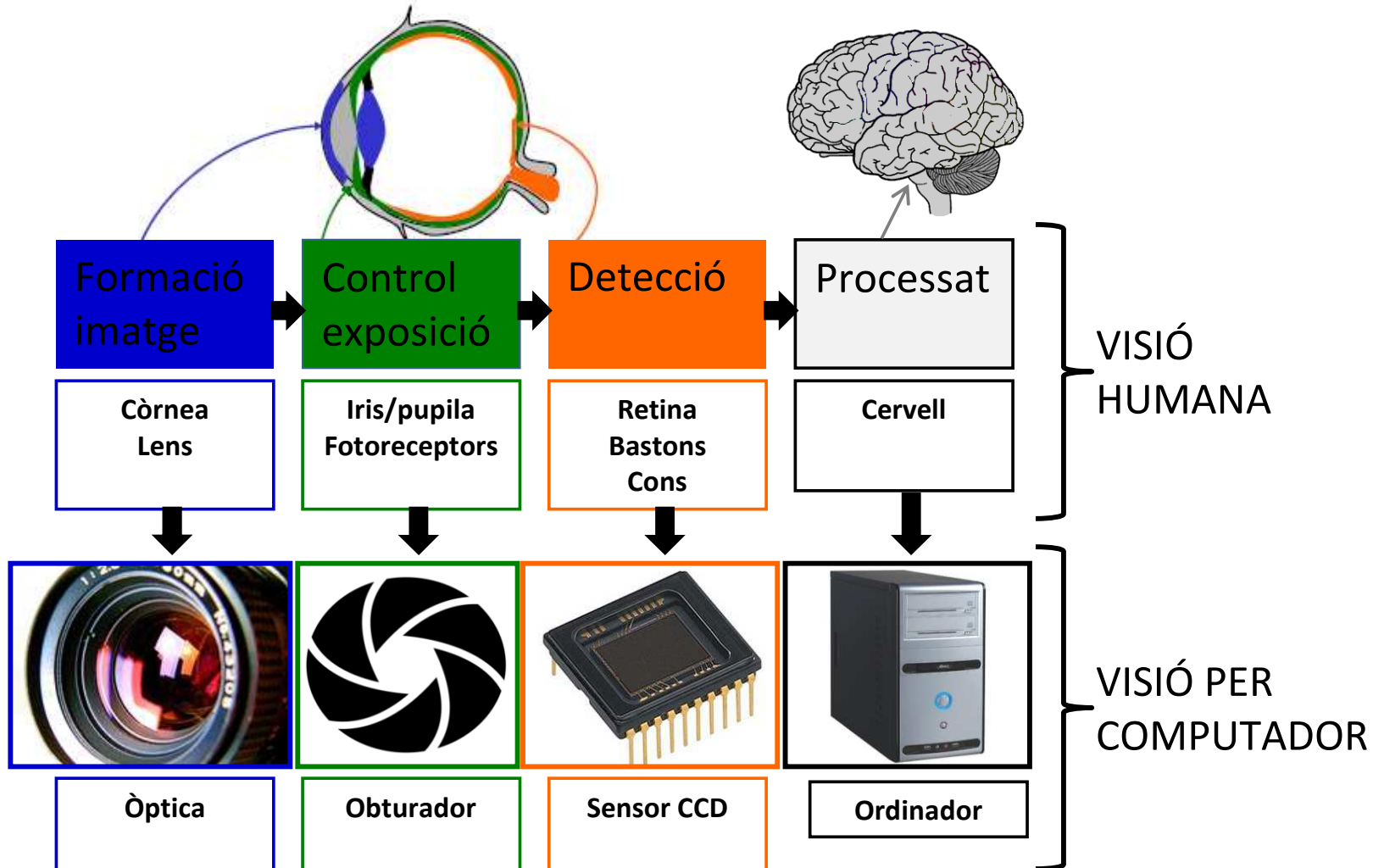
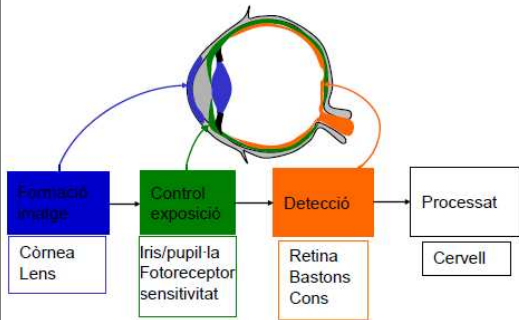

Pin-hole

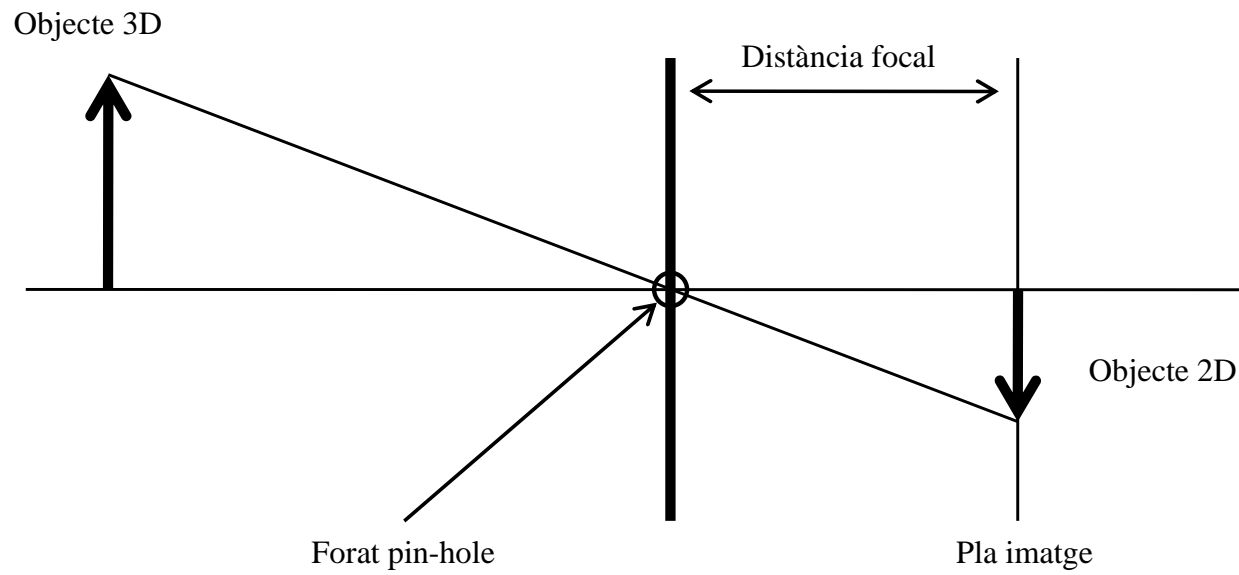

Projecció perspectiva

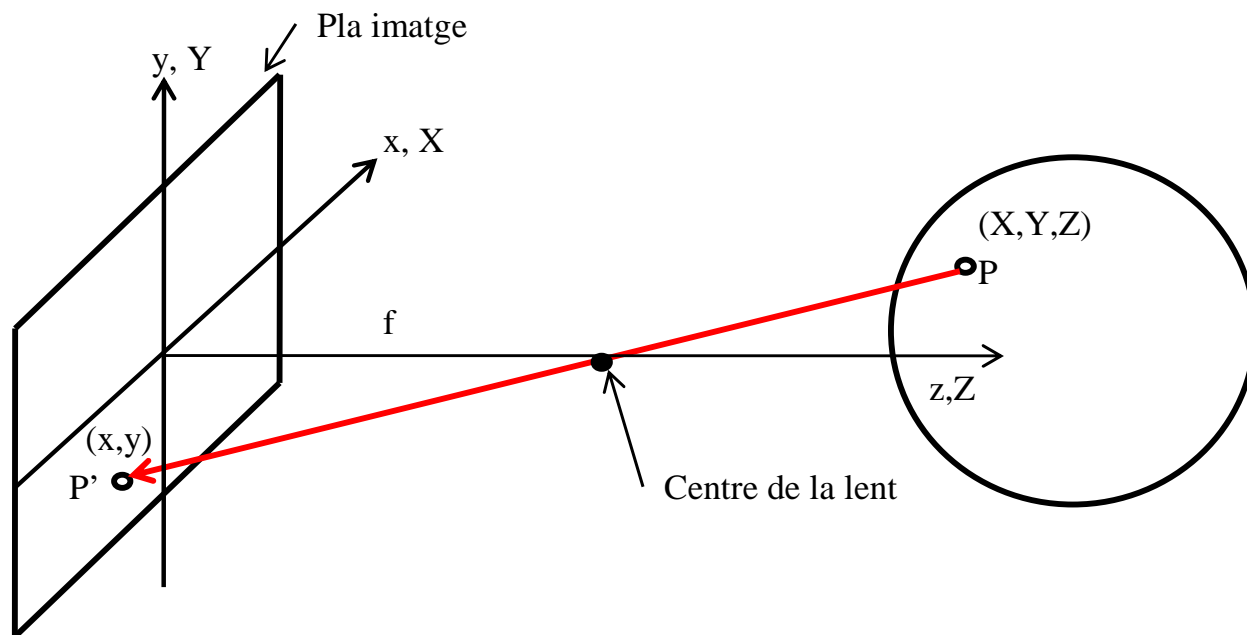

Projeccio ortografica

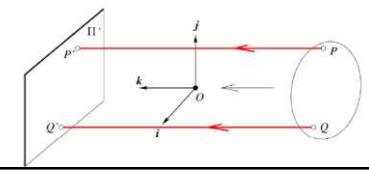
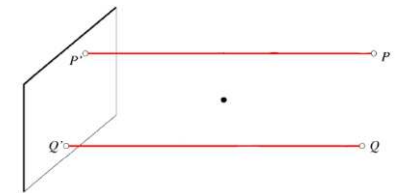
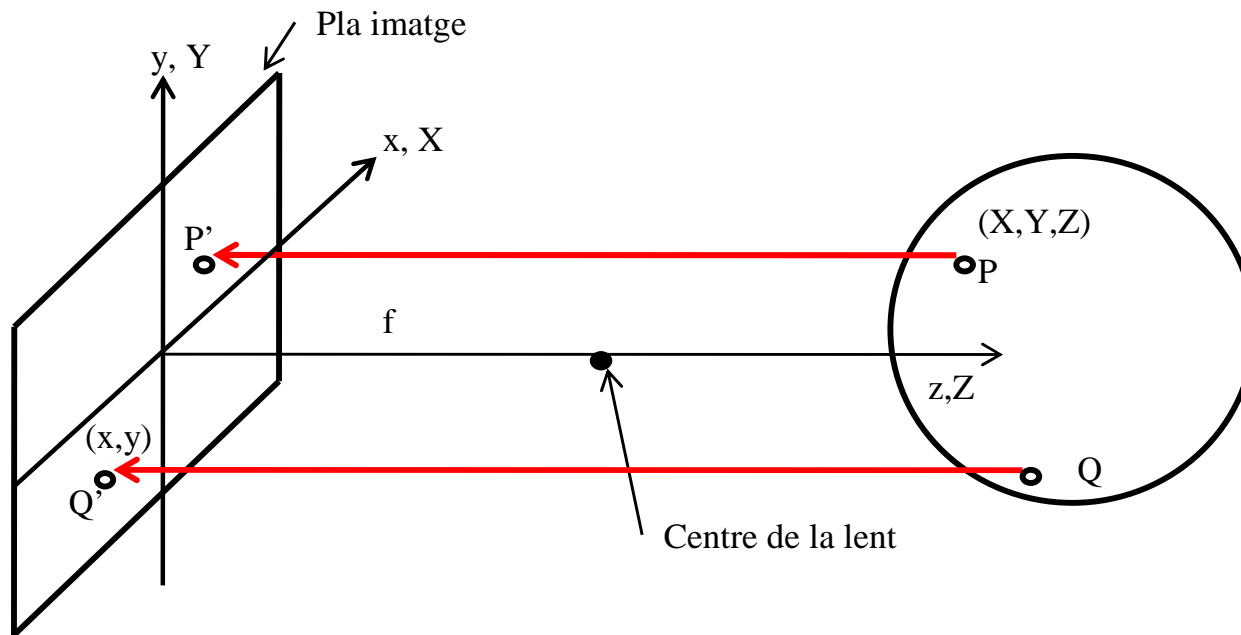

Estratègia Pc104

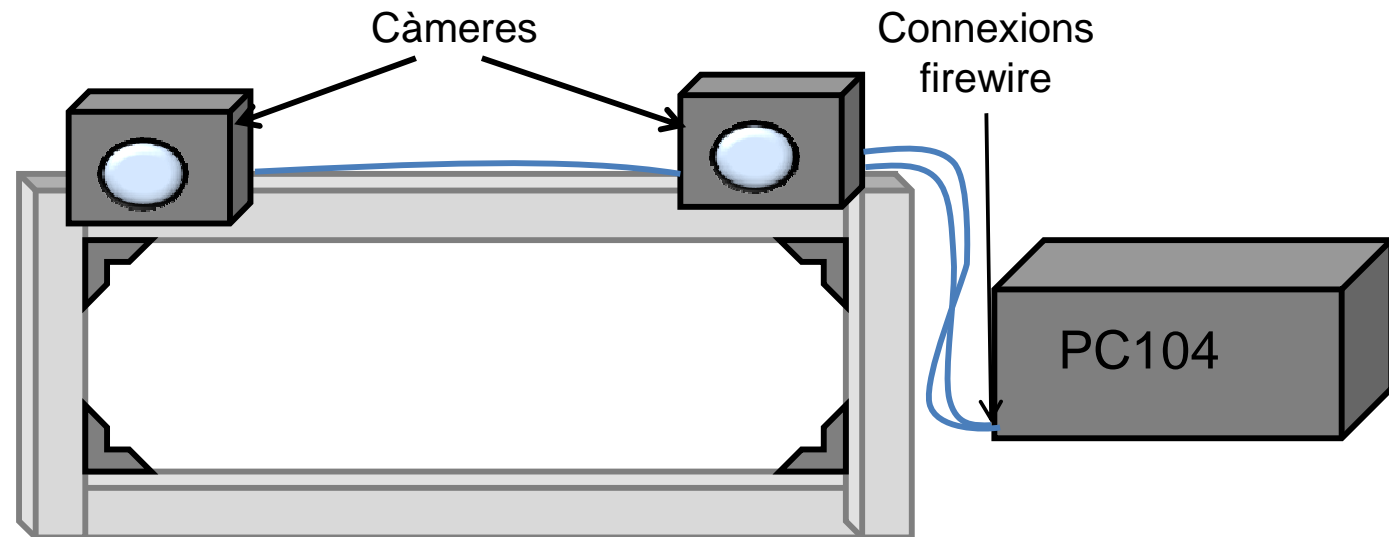
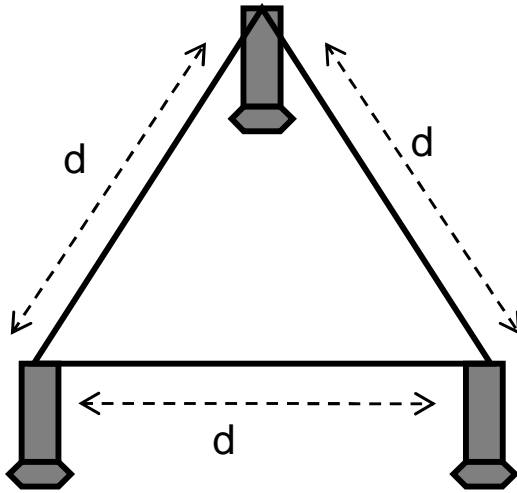

Estrategia laptop : Wet pc

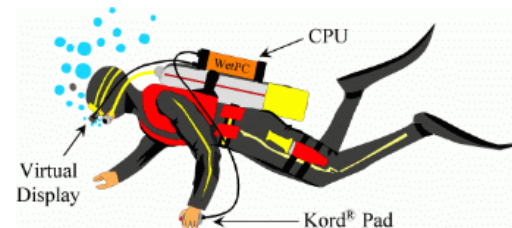
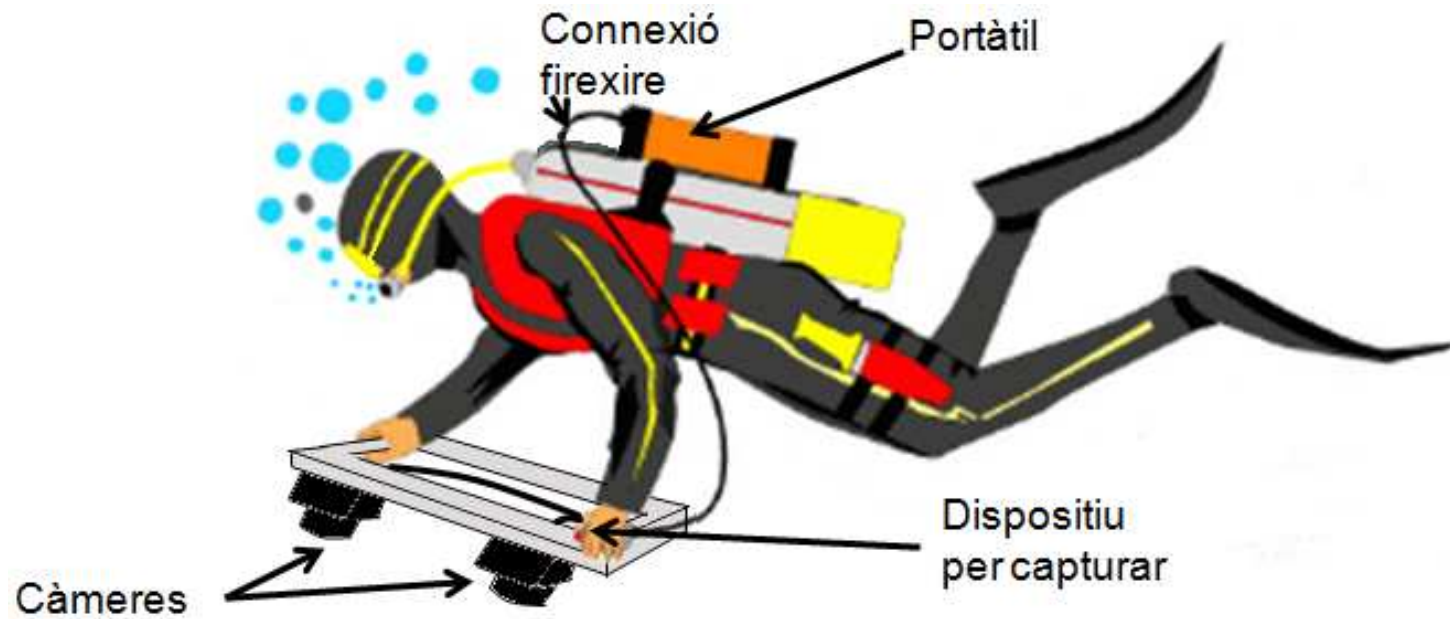

Estratègia Cameres amb targetes

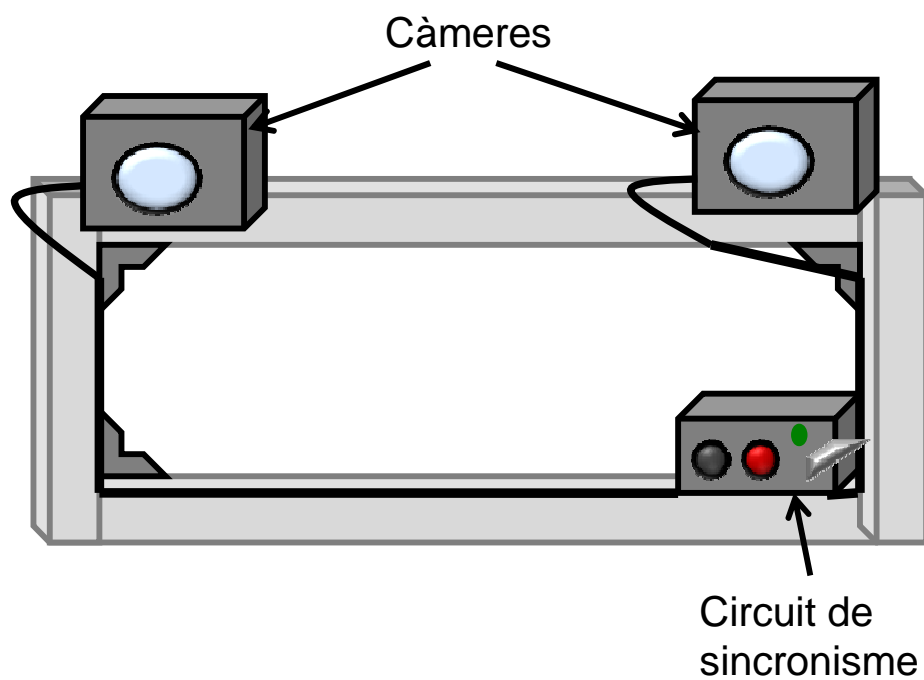

CAMERES REFLEX

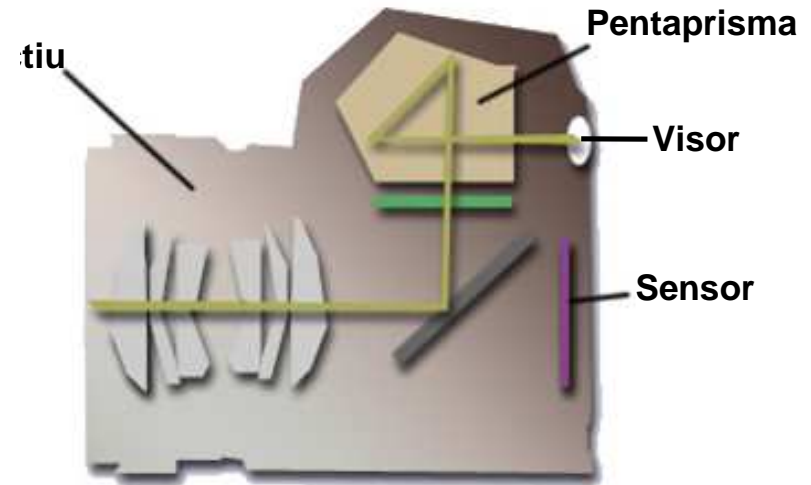

CIRCUIT SINCRONISME

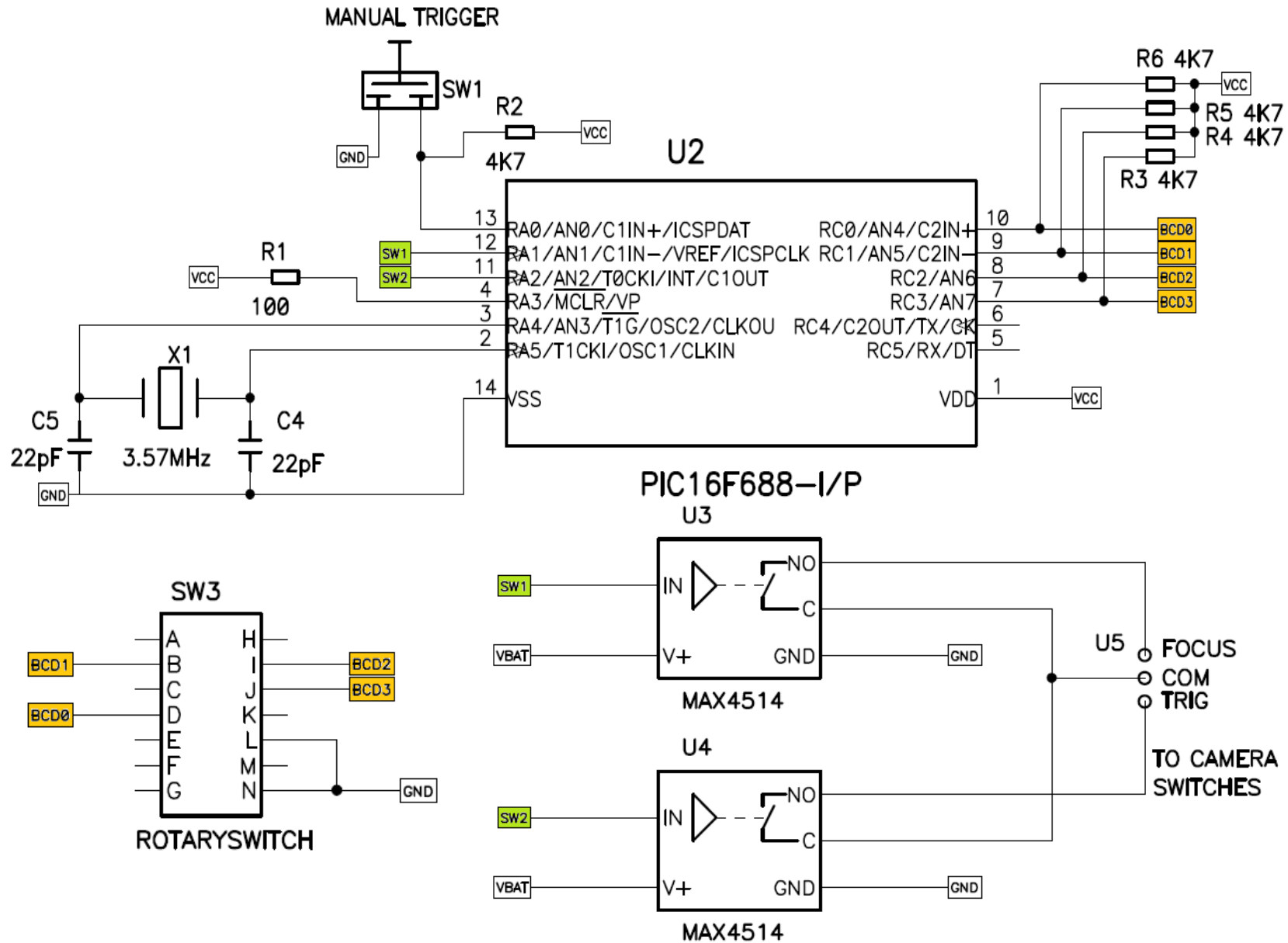

Estructura de suport

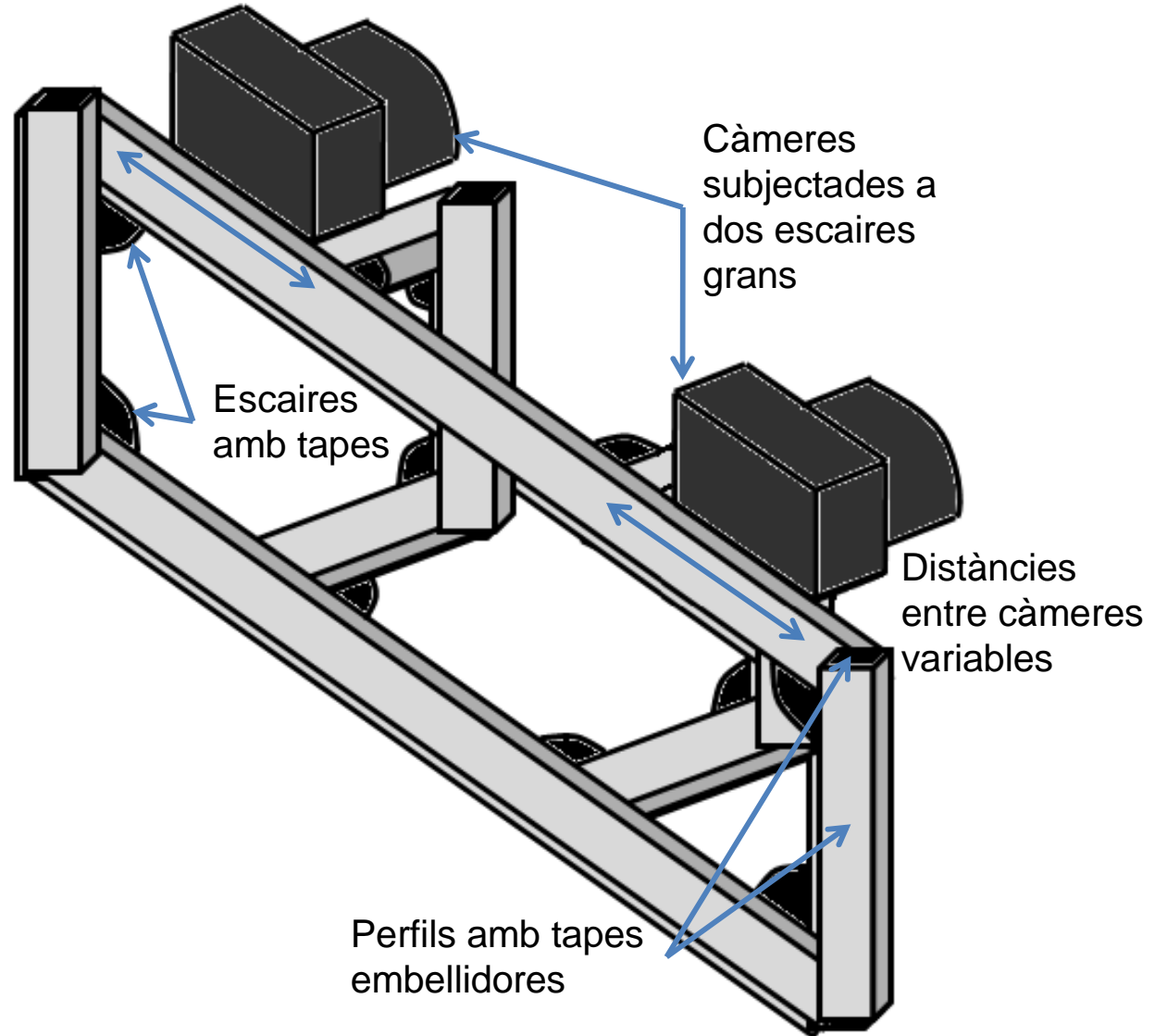
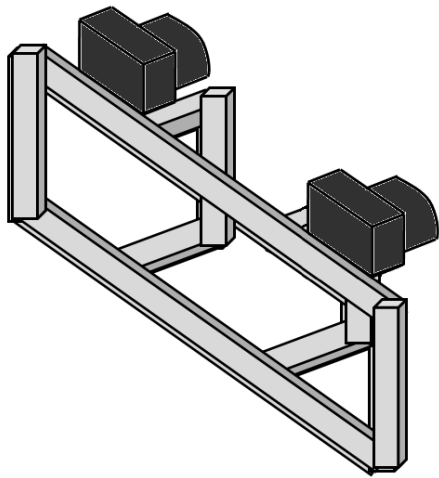

Càmeres
subjectades a
dos escaires
grans

Escaires
amb tapes

Distàncies
entre càmeres
variables

Perfils amb tapes
embellidores

placa

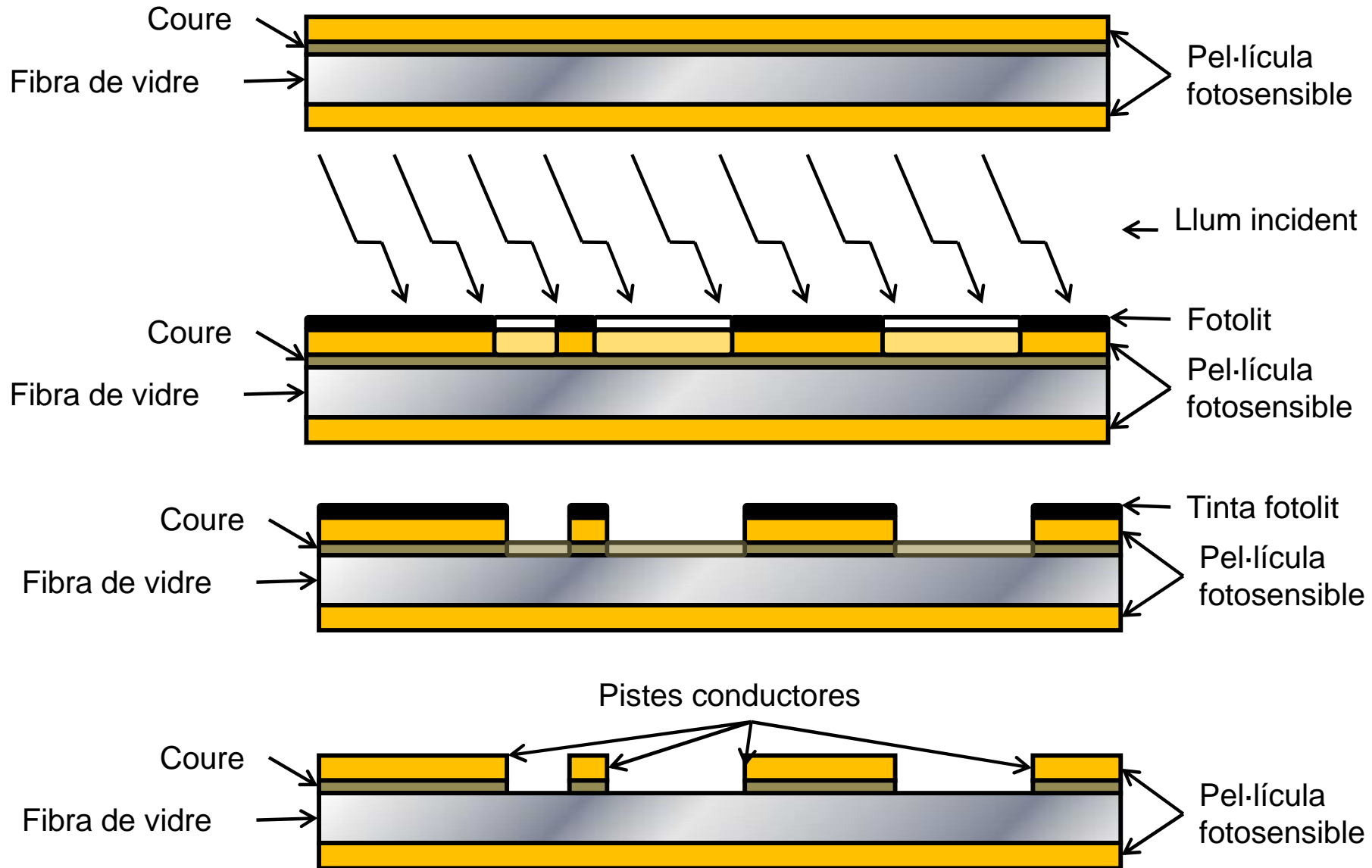

Temps cameraTrigger

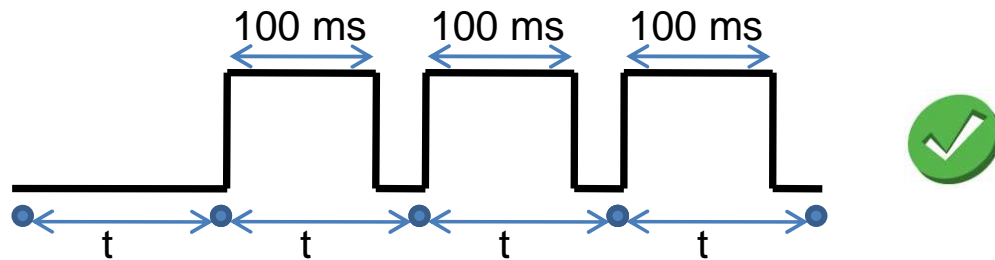
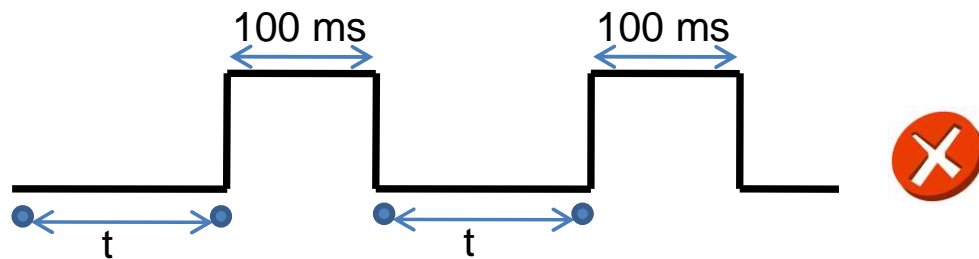
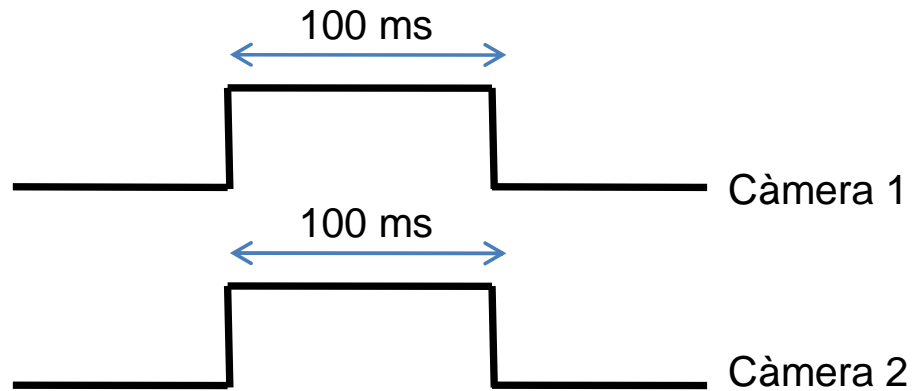

CIRCUIT

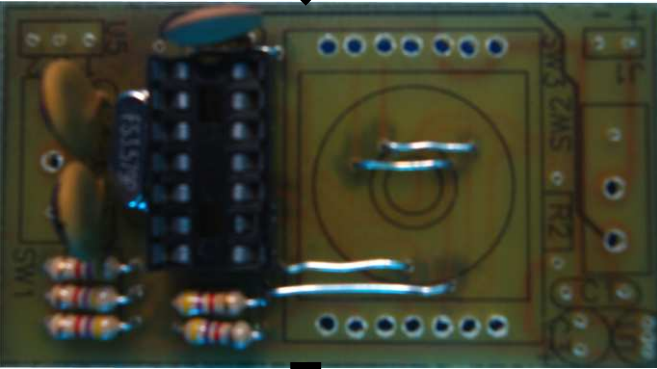
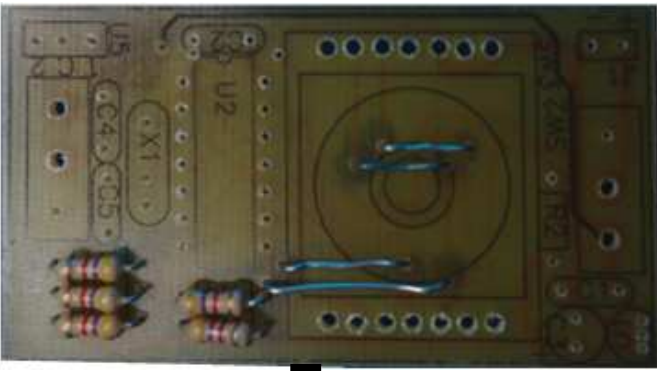

resultats

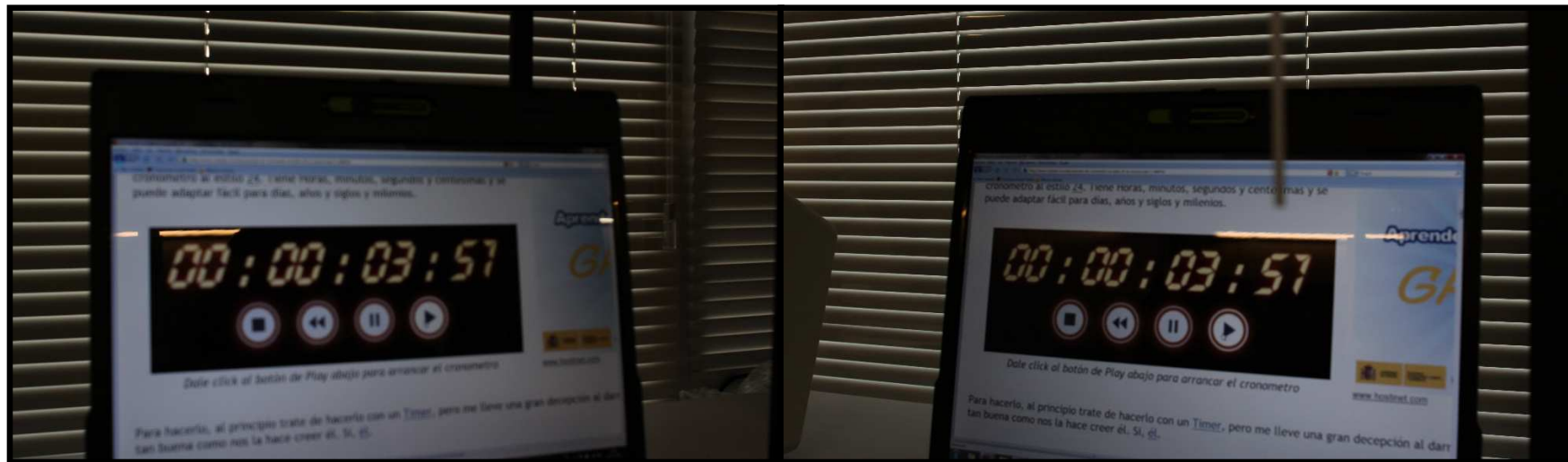

results2



calibració

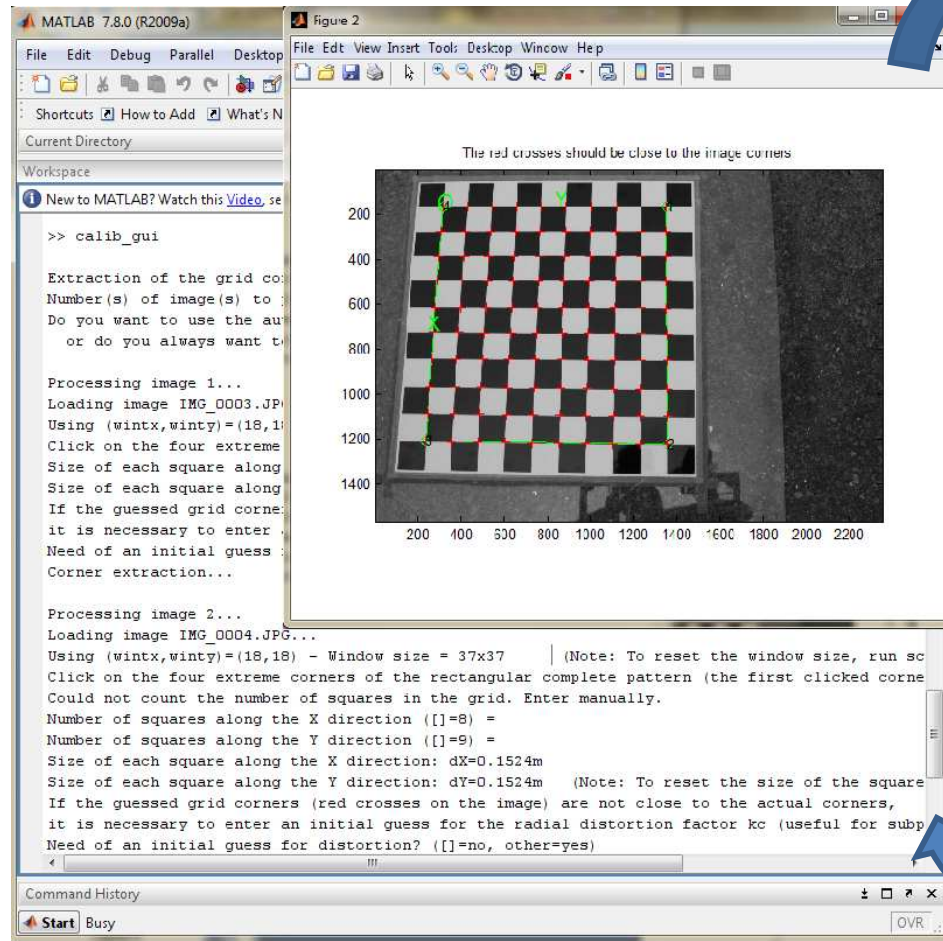

Extreure els
corners

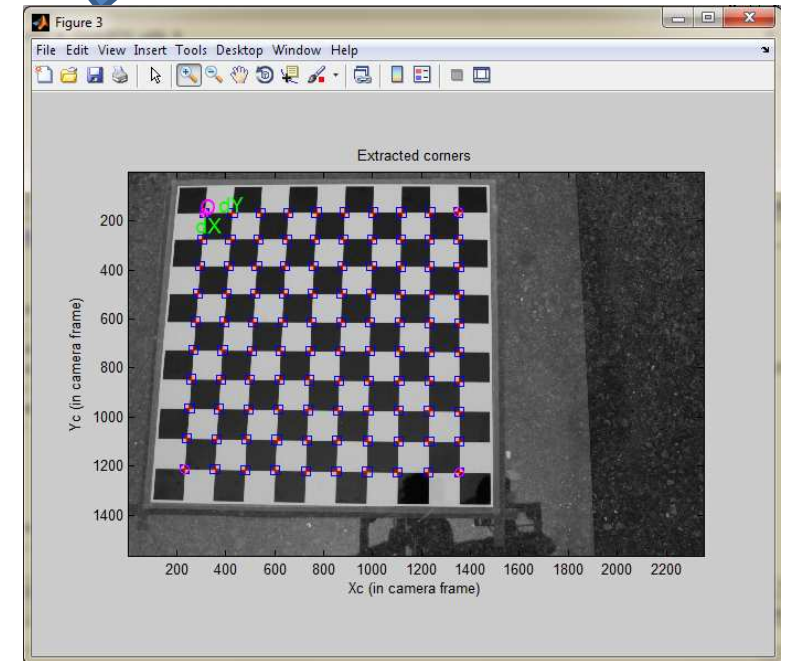

Per cada
imatge

calibració

Càmera esquerra:

Calibration results (with uncertainties):

Focal Length: $fc = [2641.46819 \quad 2641.46819] \pm [5.50659 \quad 5.50659]$
Principal point: $cc = [1171.16768 \quad 806.10335] \pm [1.56366 \quad 3.14623]$
Skew: $\alpha_c = [0.00000] \pm [0.00000] \Rightarrow$ angle of pixel axes = 90.00000 ± 0.00000 degrees
Distortion: $kc = [-0.08200 \quad 0.00000 \quad -0.00118 \quad -0.00000 \quad 0.00000] \pm [0.00114 \quad 0.00000 \quad 0.00028 \quad 0.00000 \quad 0.00000]$

Càmera dreta:

Calibration results (with uncertainties):

Focal Length: $fc = [2626.58373 \quad 2626.58373] \pm [5.14031 \quad 5.14031]$
Principal point: $cc = [1170.98111 \quad 773.16358] \pm [1.63917 \quad 3.31582]$
Skew: $\alpha_c = [0.00000] \pm [0.00000] \Rightarrow$ angle of pixel axes = 90.00000 ± 0.00000 degrees
Distortion: $kc = [-0.07521 \quad 0.00000 \quad -0.00309 \quad -0.00000 \quad 0.00000] \pm [0.00125 \quad 0.00000 \quad 0.00031 \quad 0.00000 \quad 0.00000]$

calibració

Extrinsic parameters (position of right camera wrt left camera):

Rotation vector:

$\text{om} = [-0.00763 \quad 0.03809 \quad 0.00022]$

Translation vector:

$T = [-215.13396 \quad 1.37844 \quad 13.36574]$

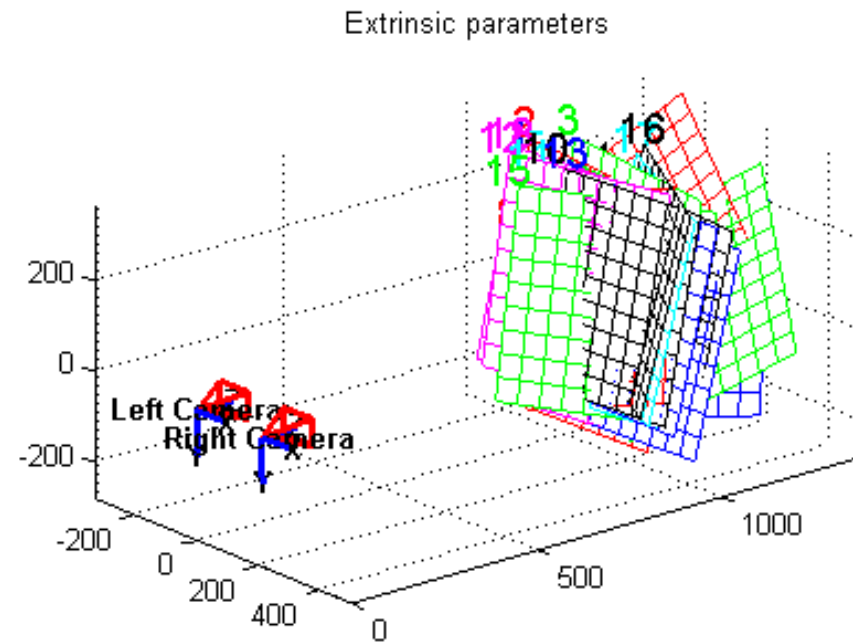
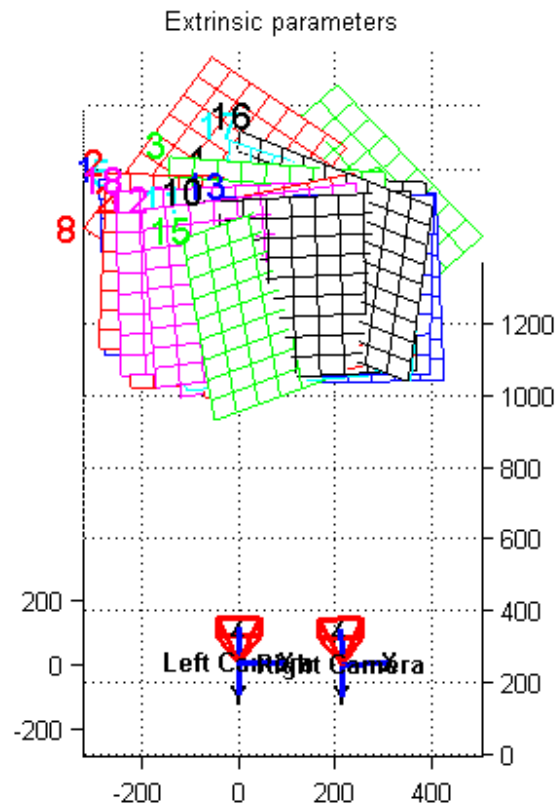

Geometria epipolar

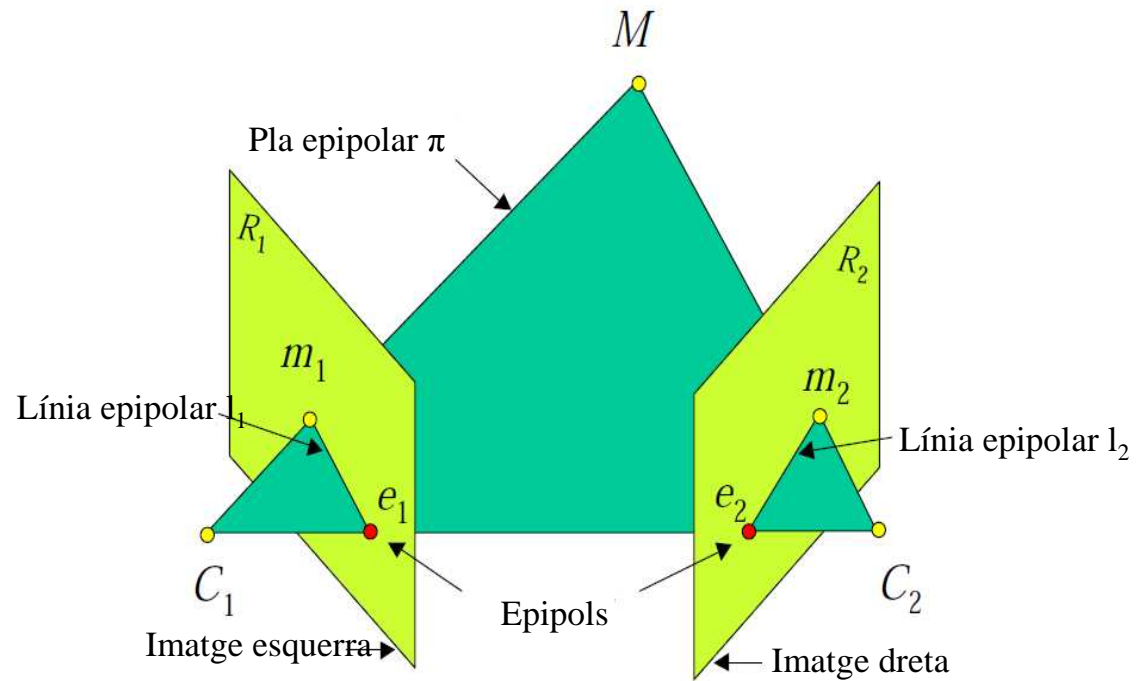

Altres reconstruccions 3d

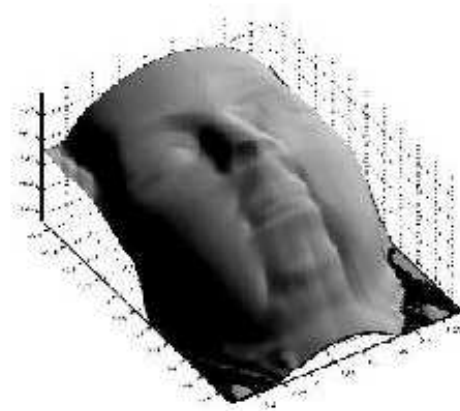
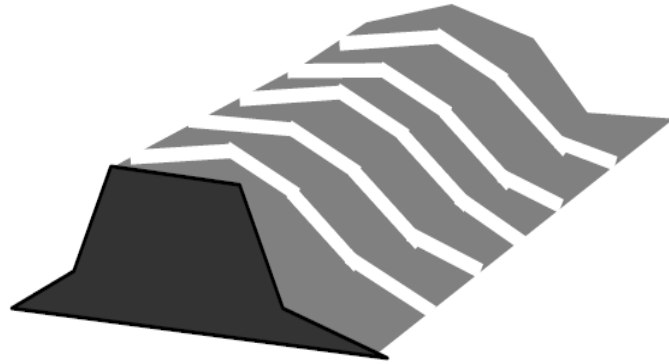
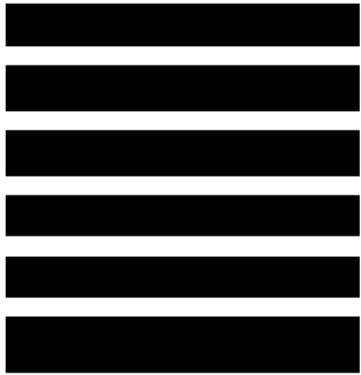

Sistema de visió estereoscòpica (dues càmeres)

Anàlisi i estudi de les càmeres



Sistema estèreo



Problema sincronisme

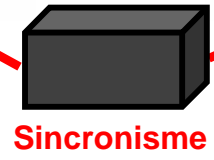

Hardware

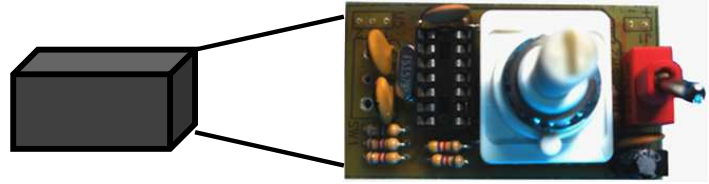

Software

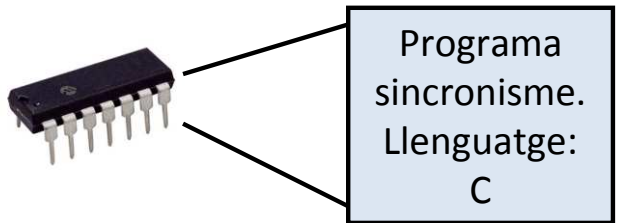

Estructura de suport

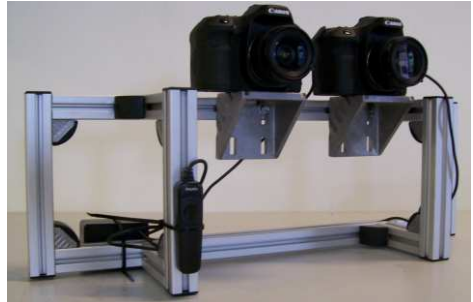

Calibració del sistema

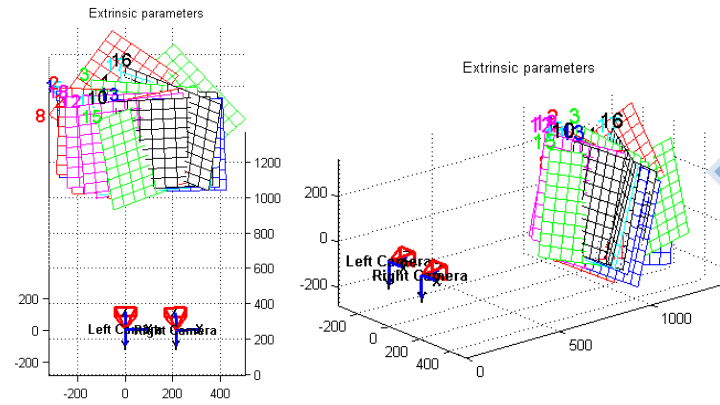

Captura de seqüències



Reconstruccions 3D

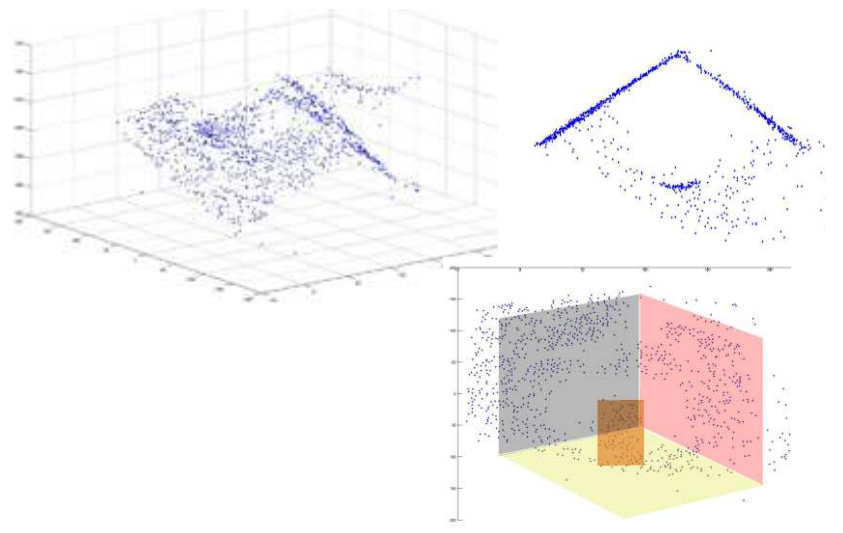
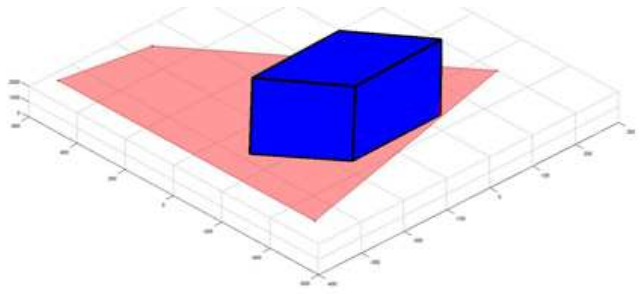

Validació del sistema

Esquema sistema

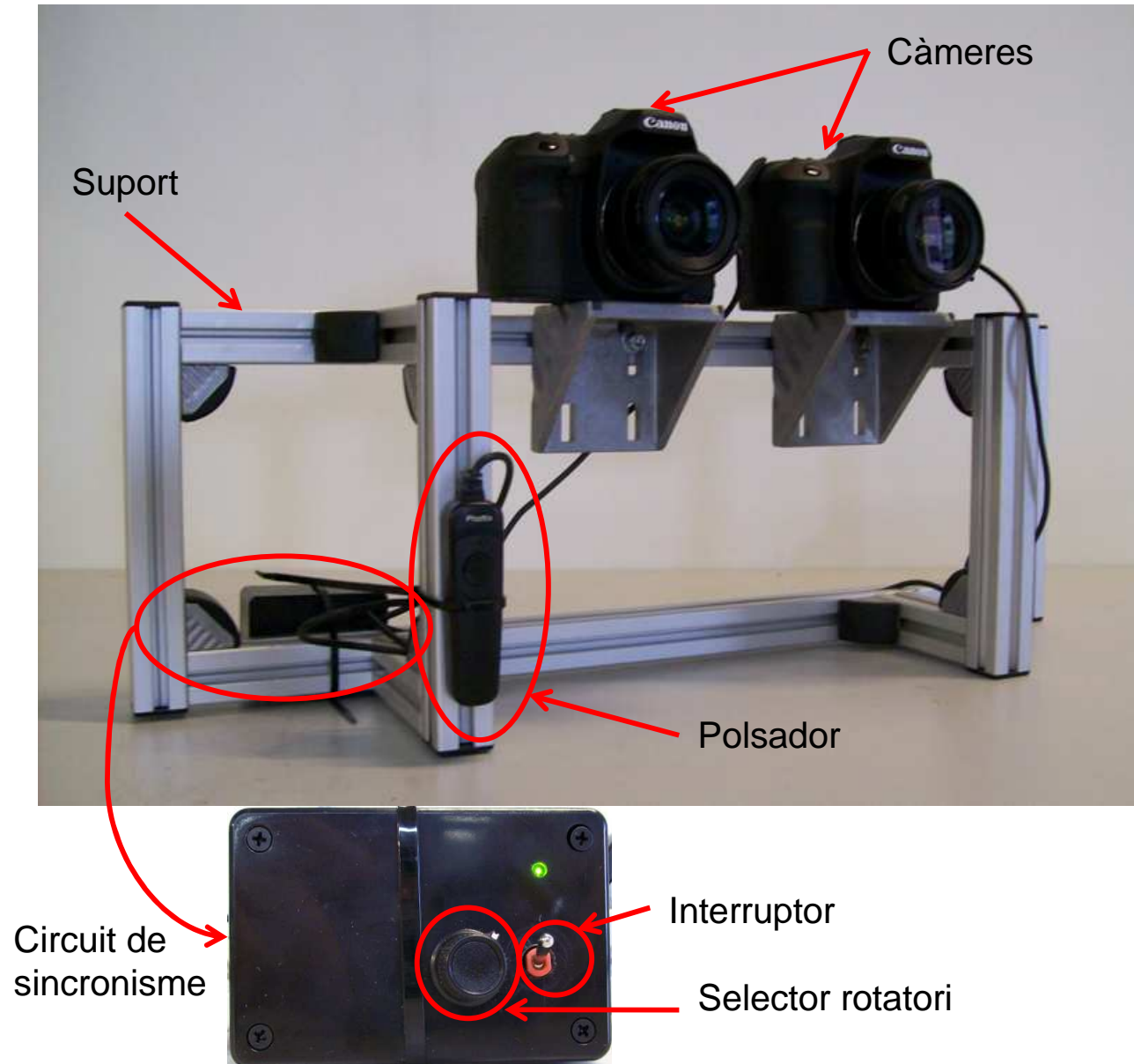

Esquema programa rec. 3D

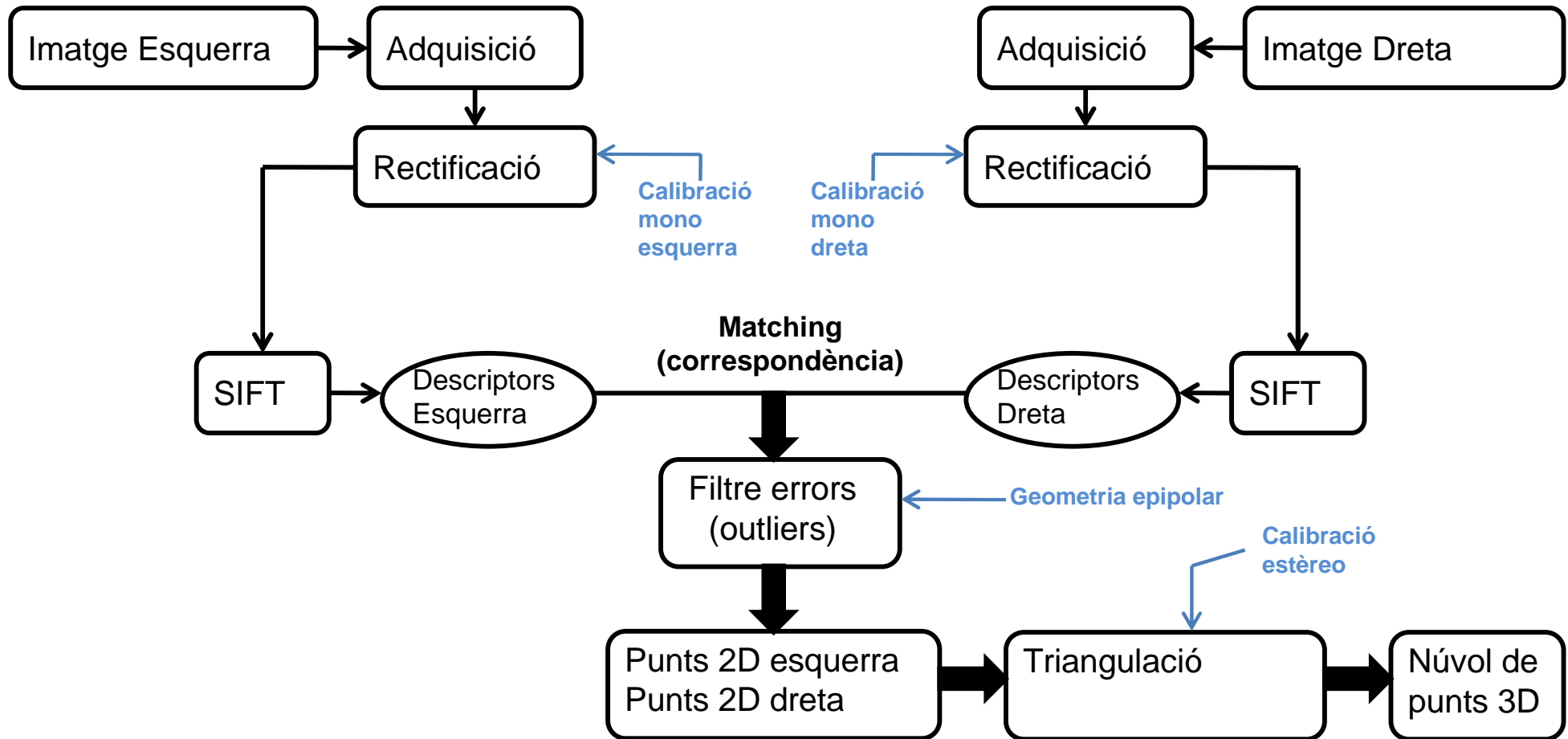

CAPTURES



RECONSTRUCCIONES 3D

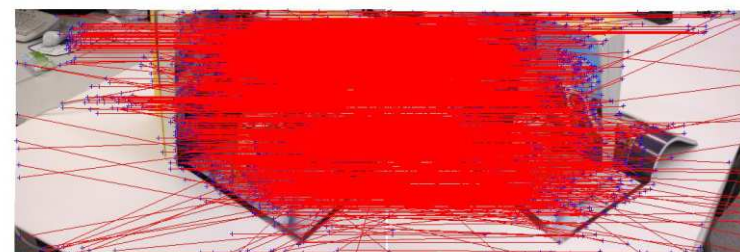
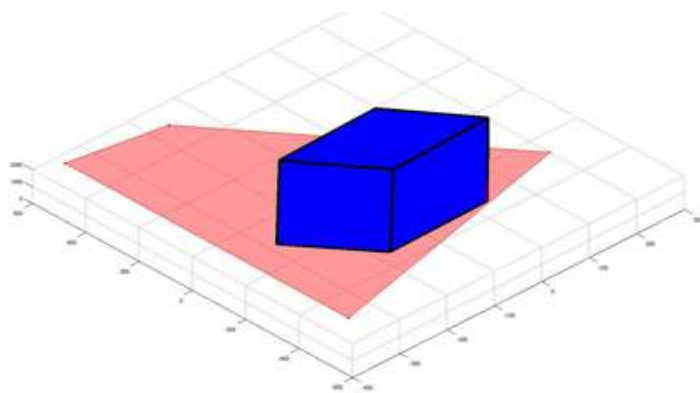

Reconstruccions 2

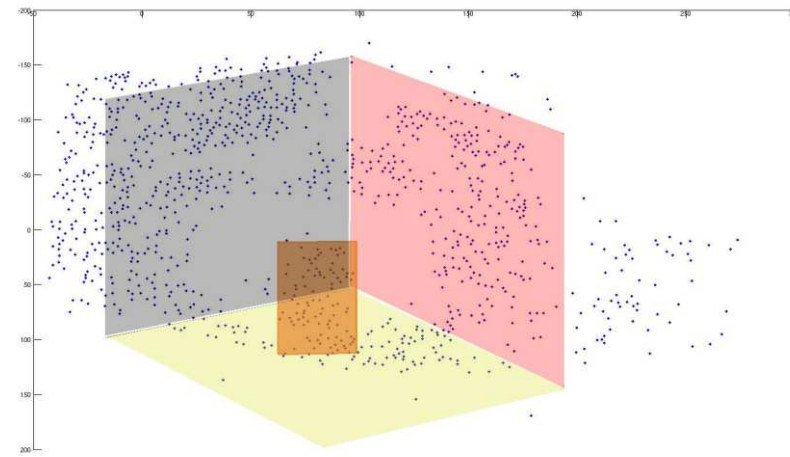
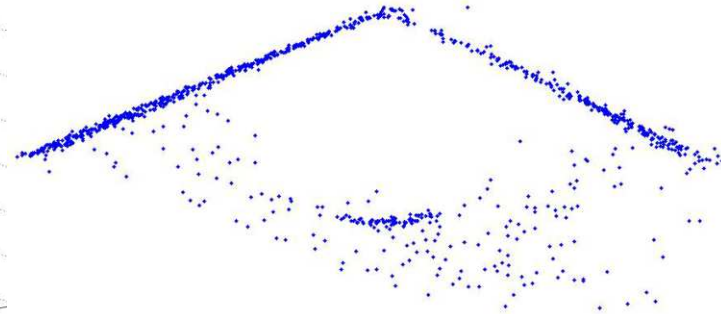
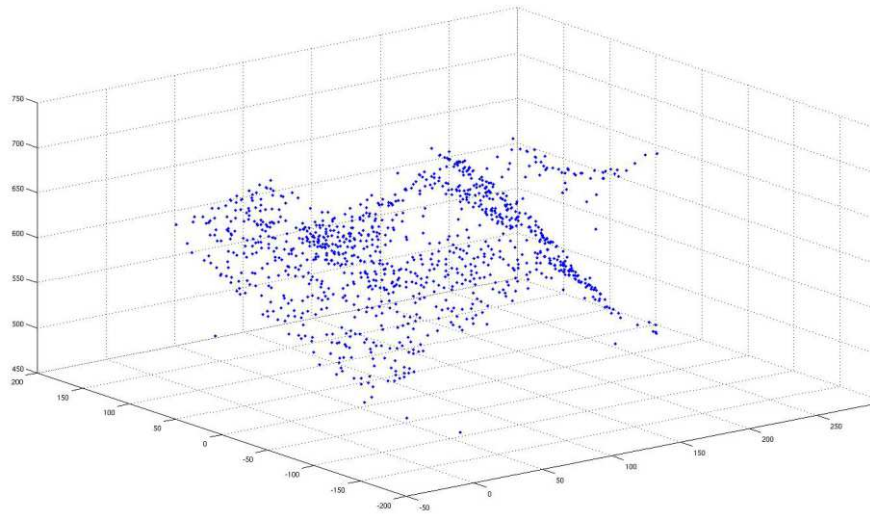

Results resum

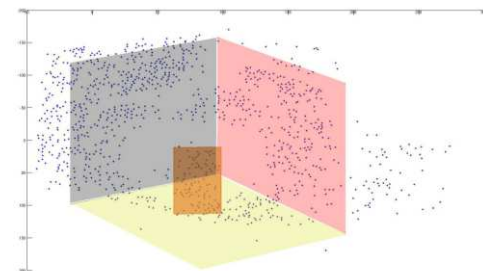
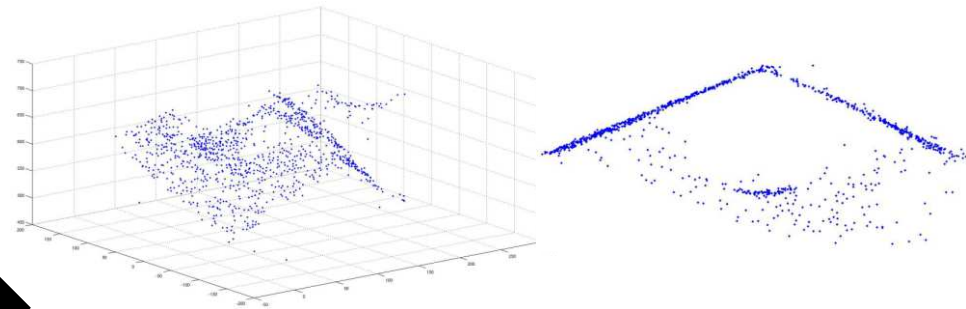
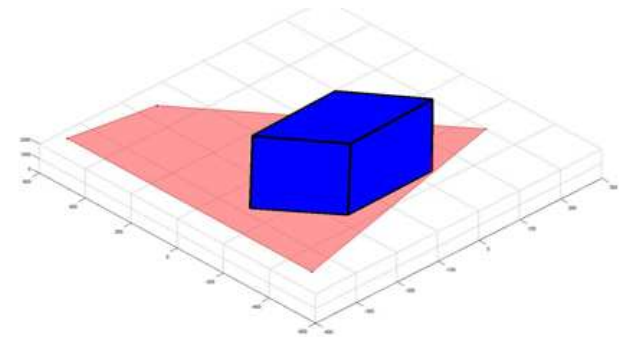

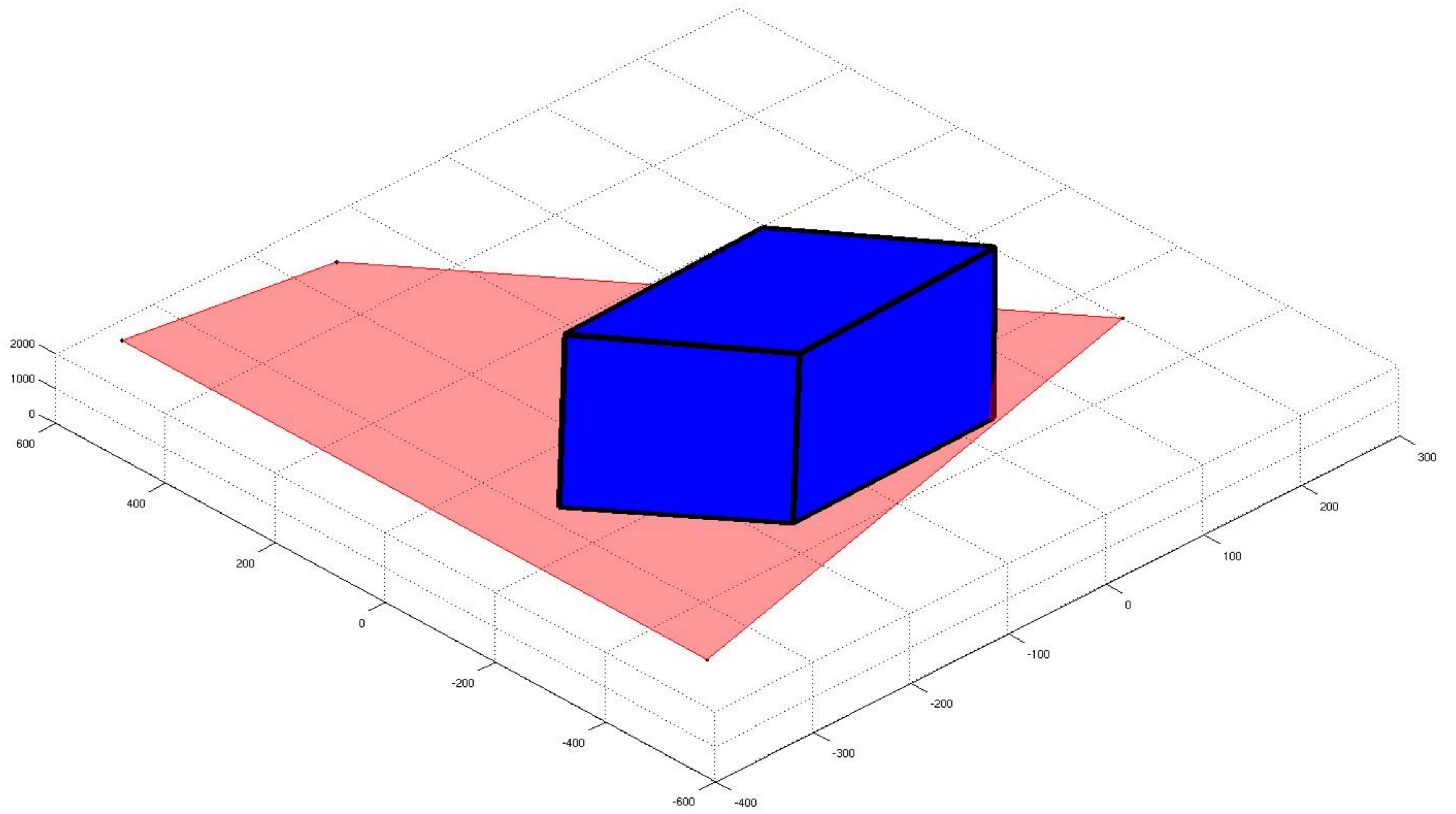

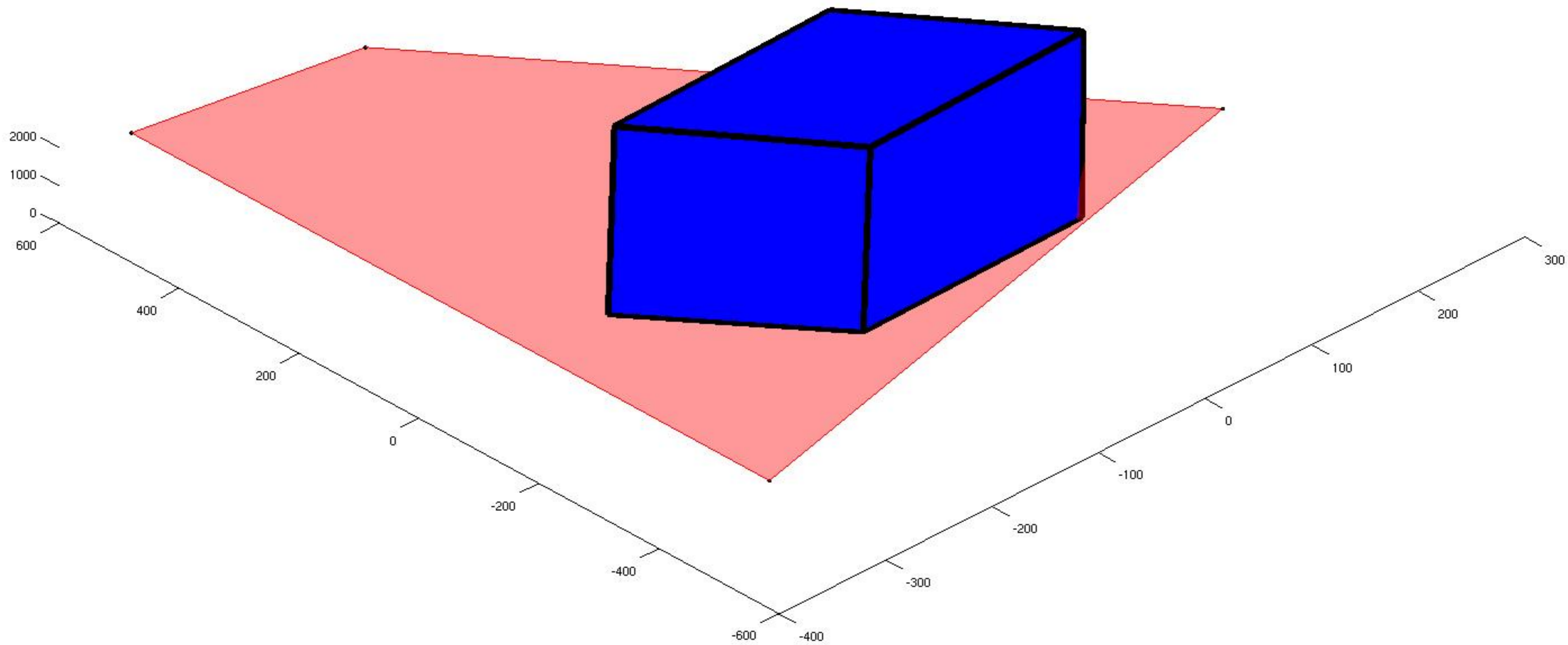

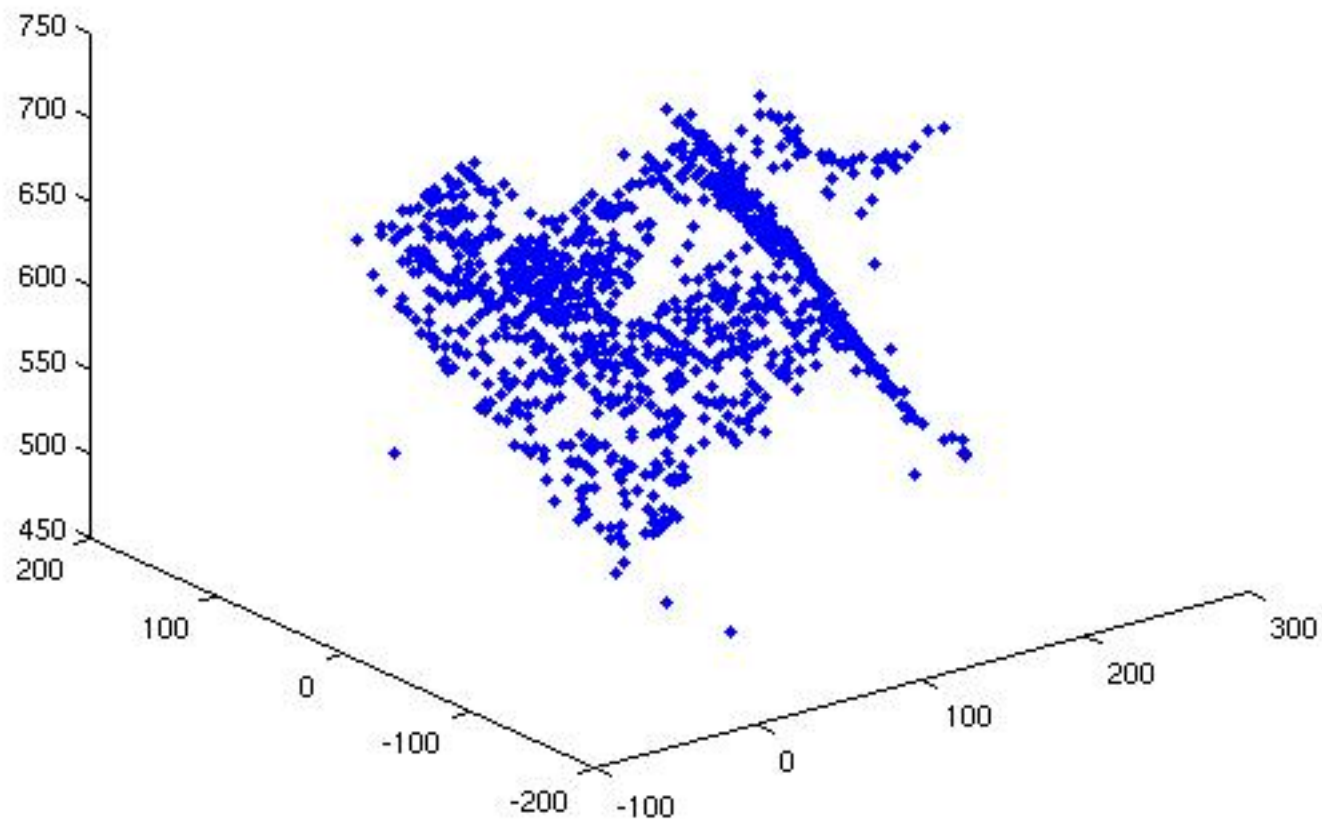

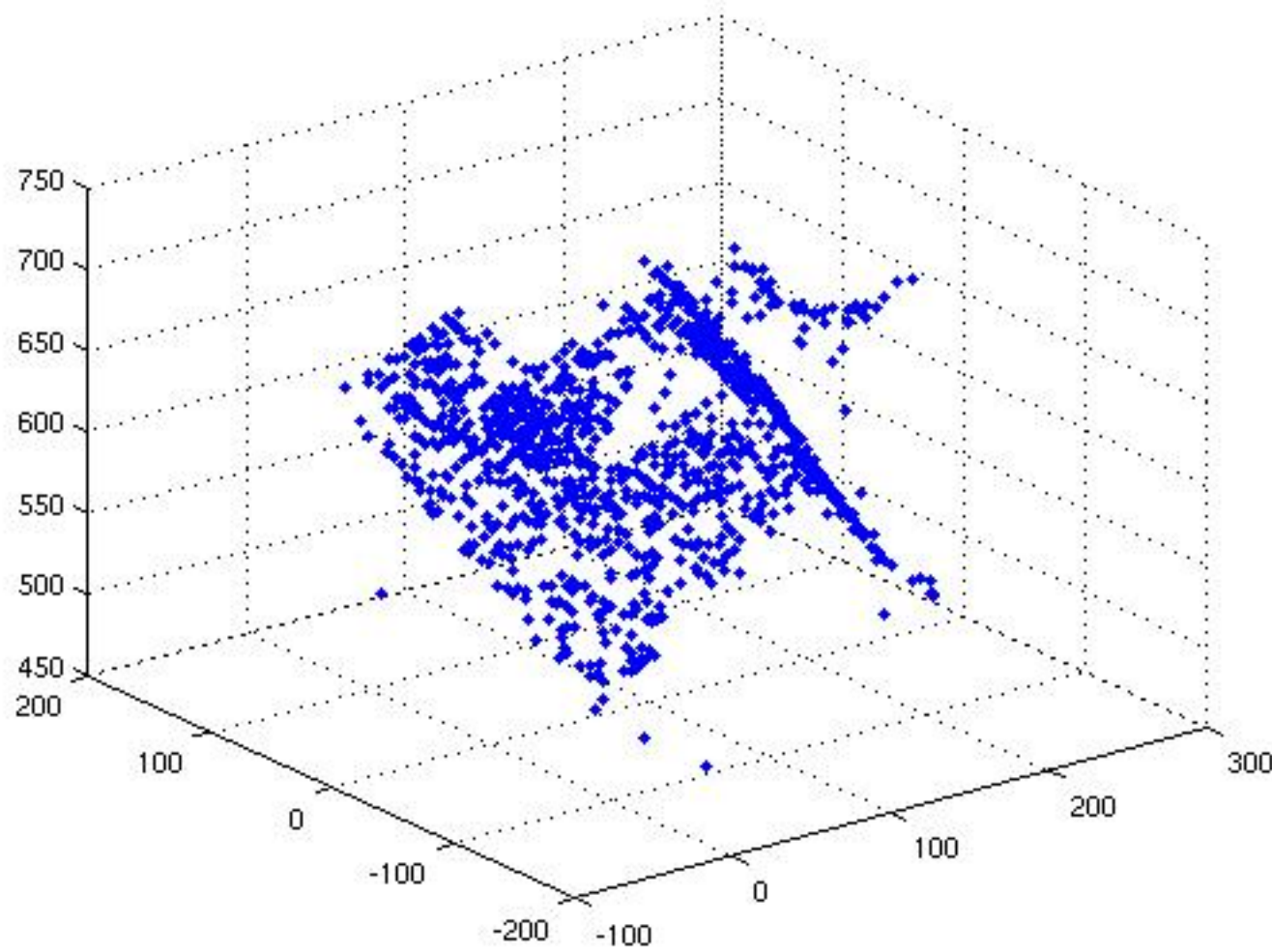

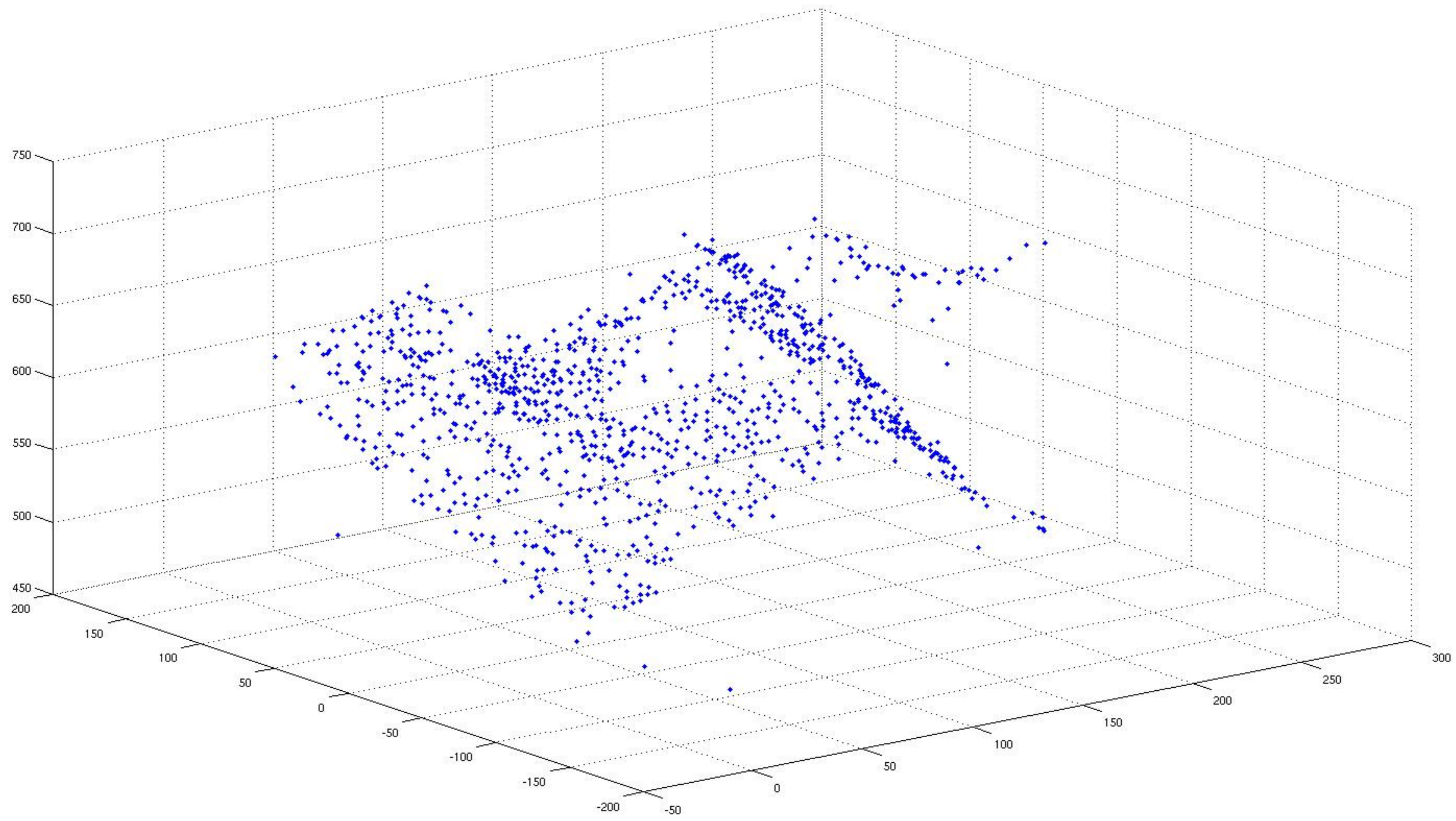

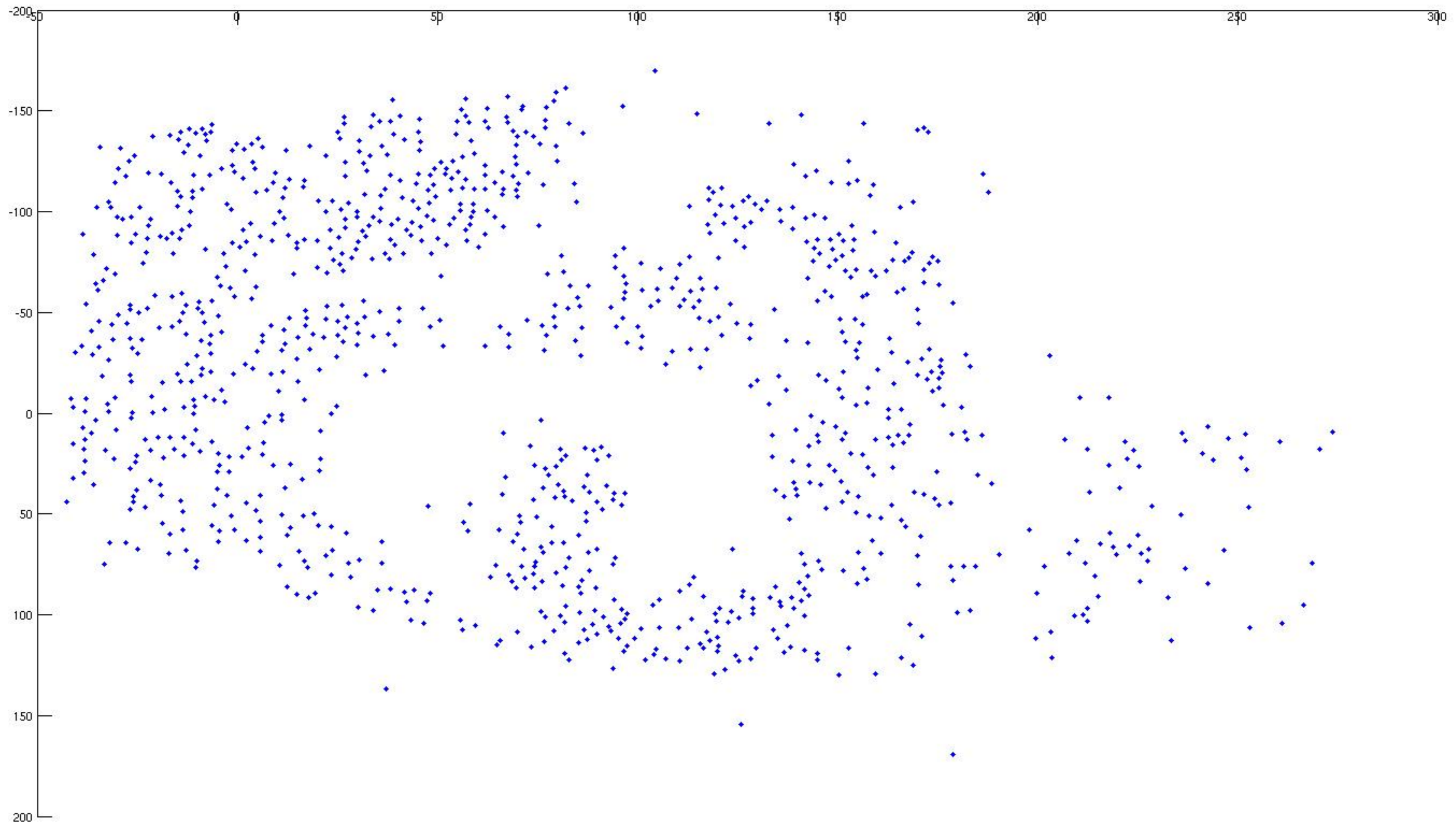

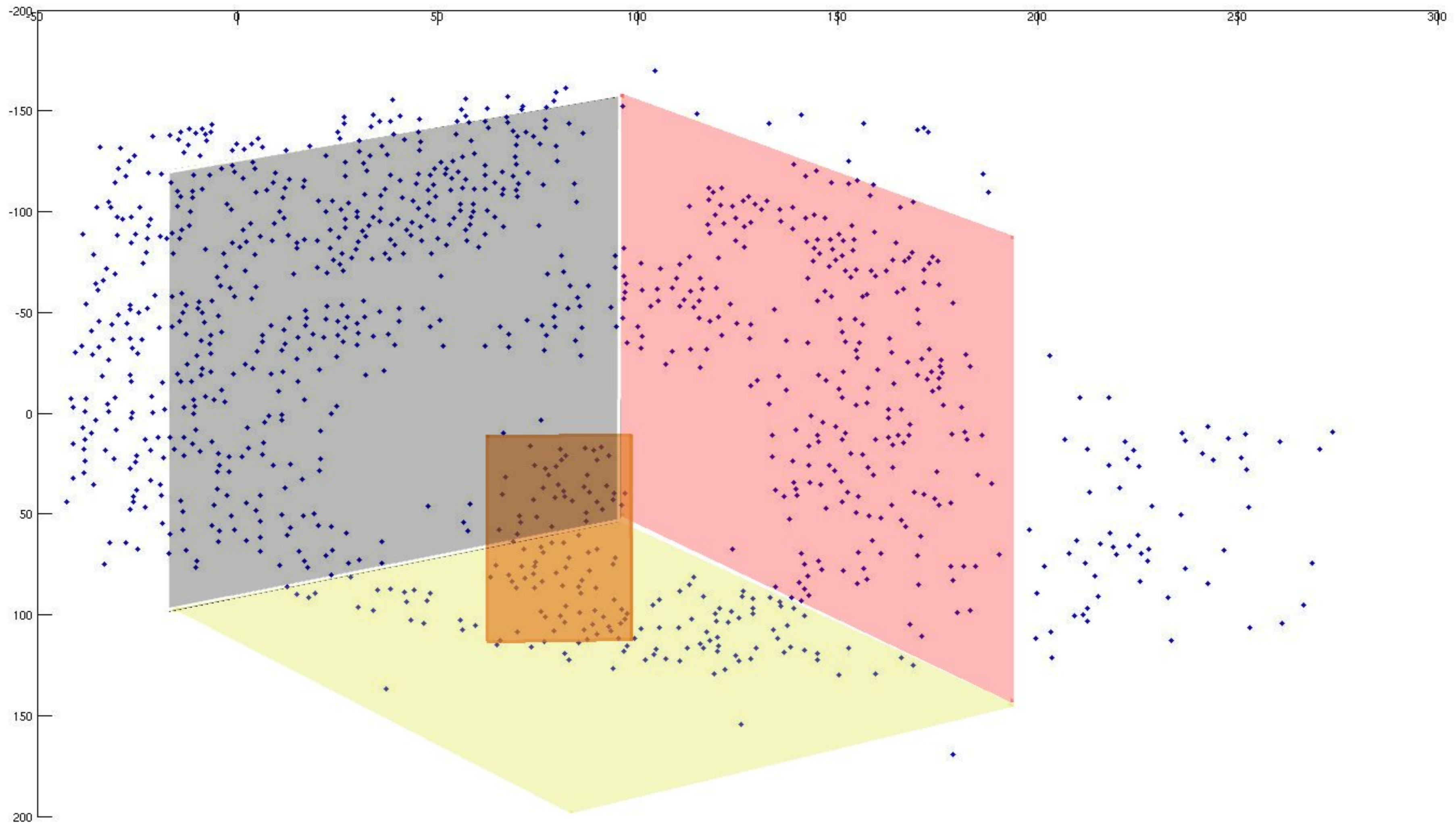

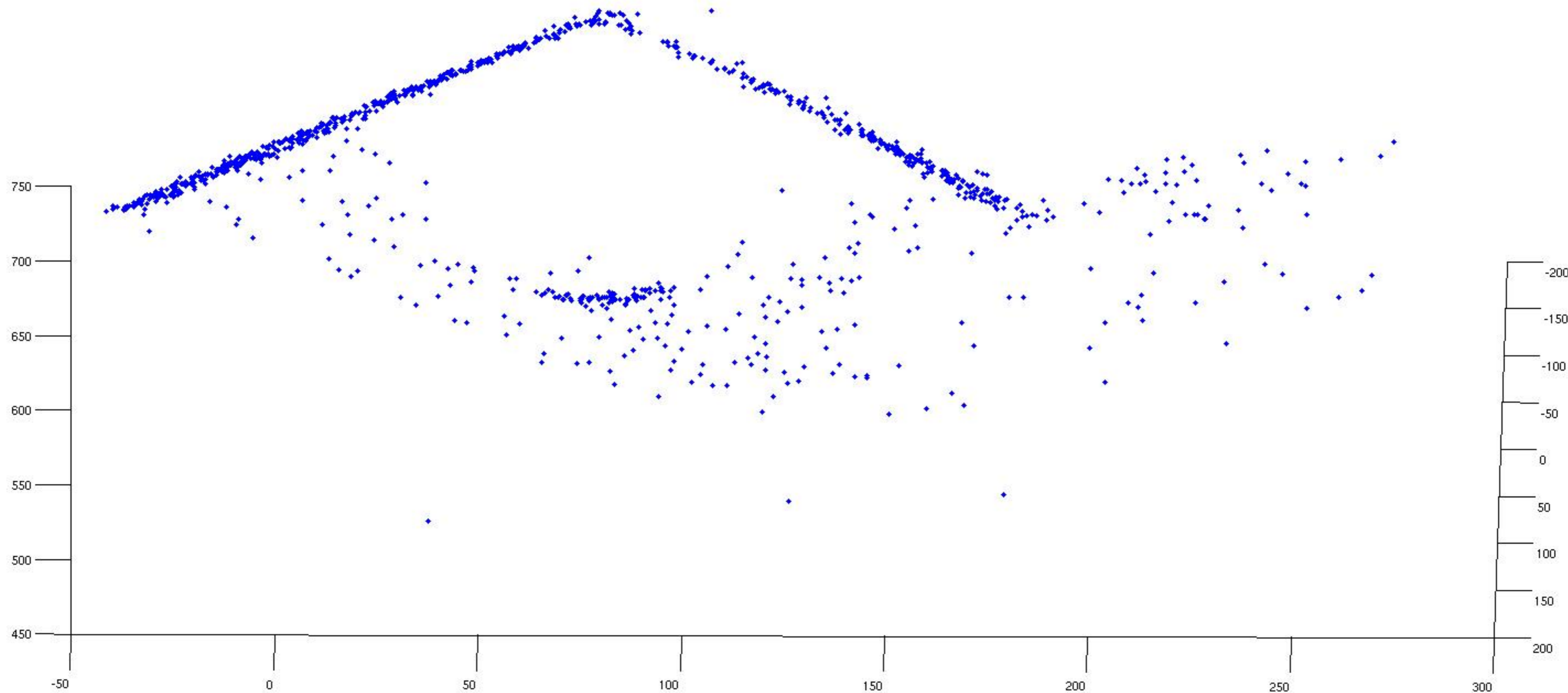





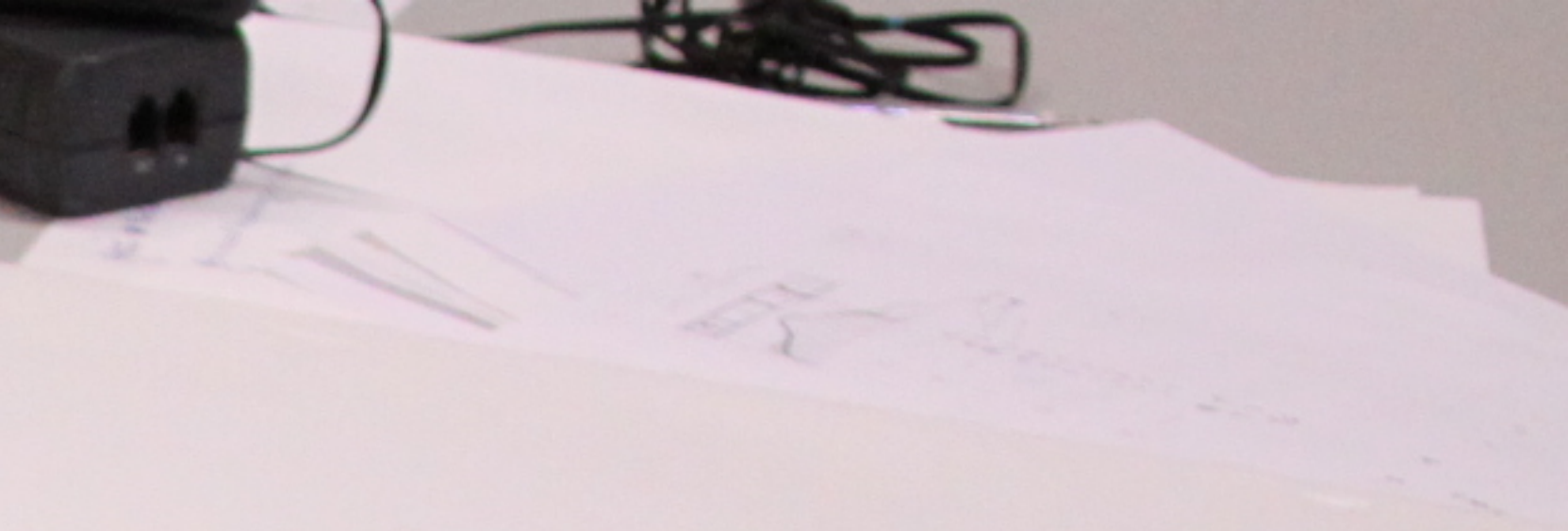
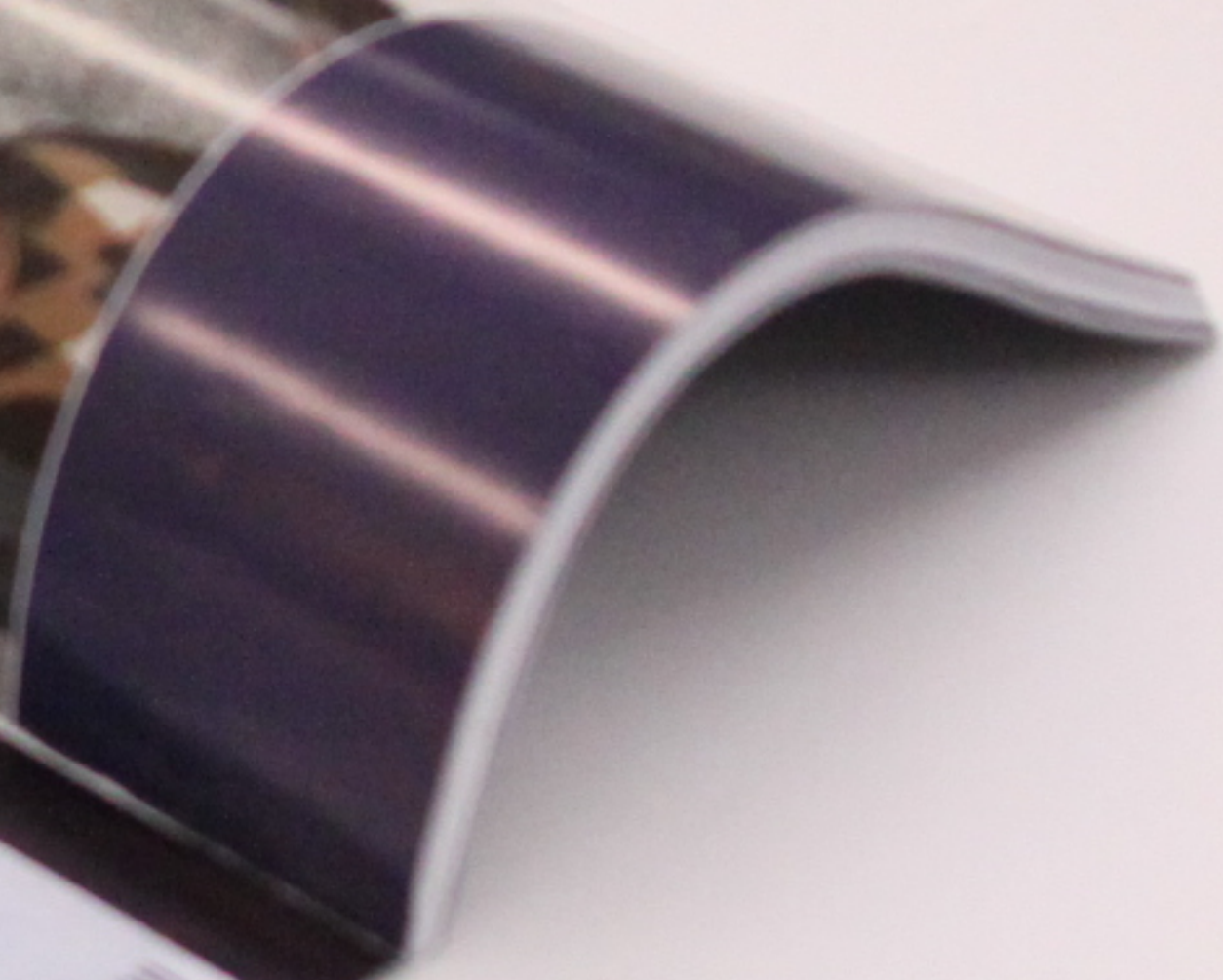
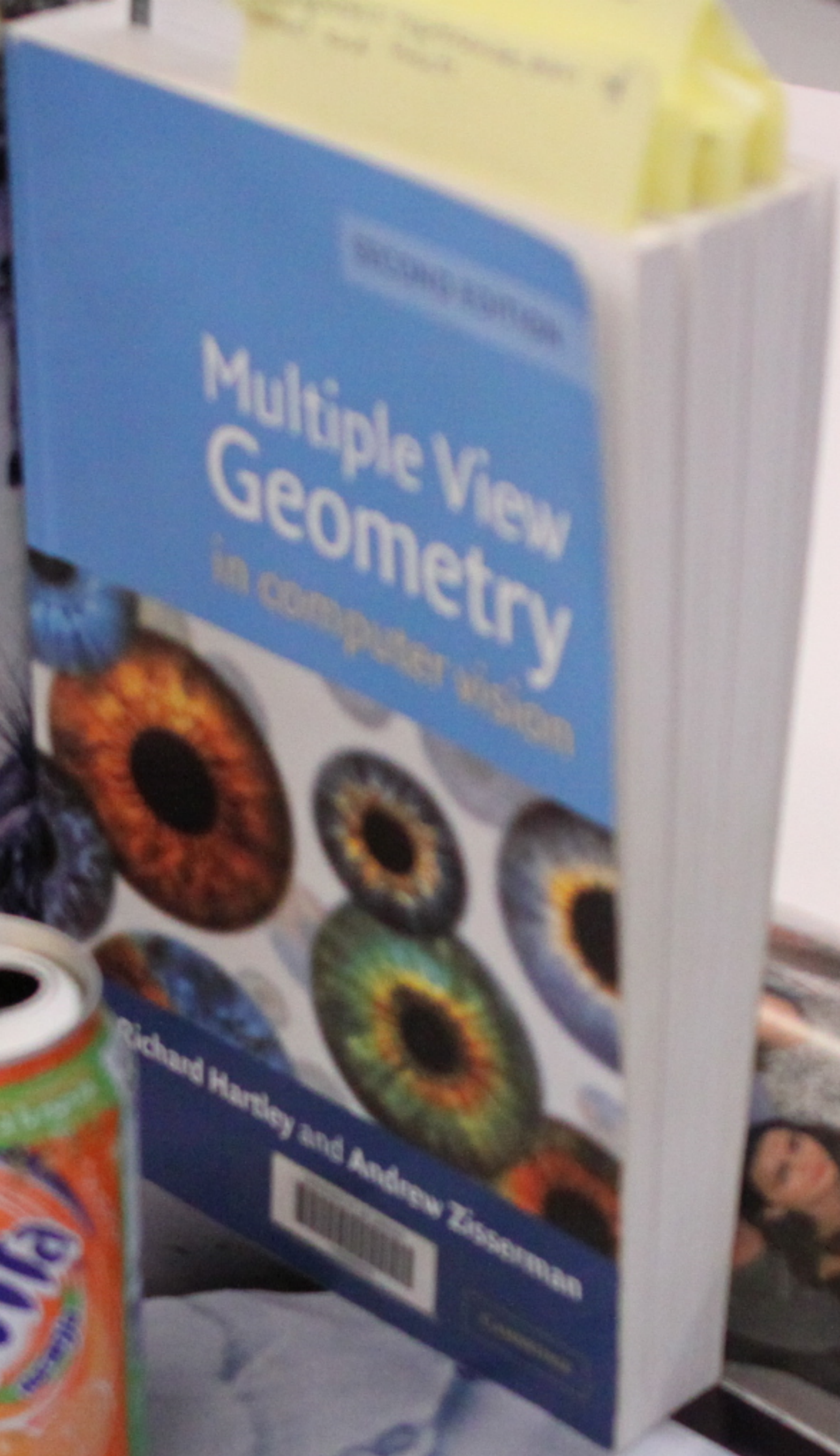



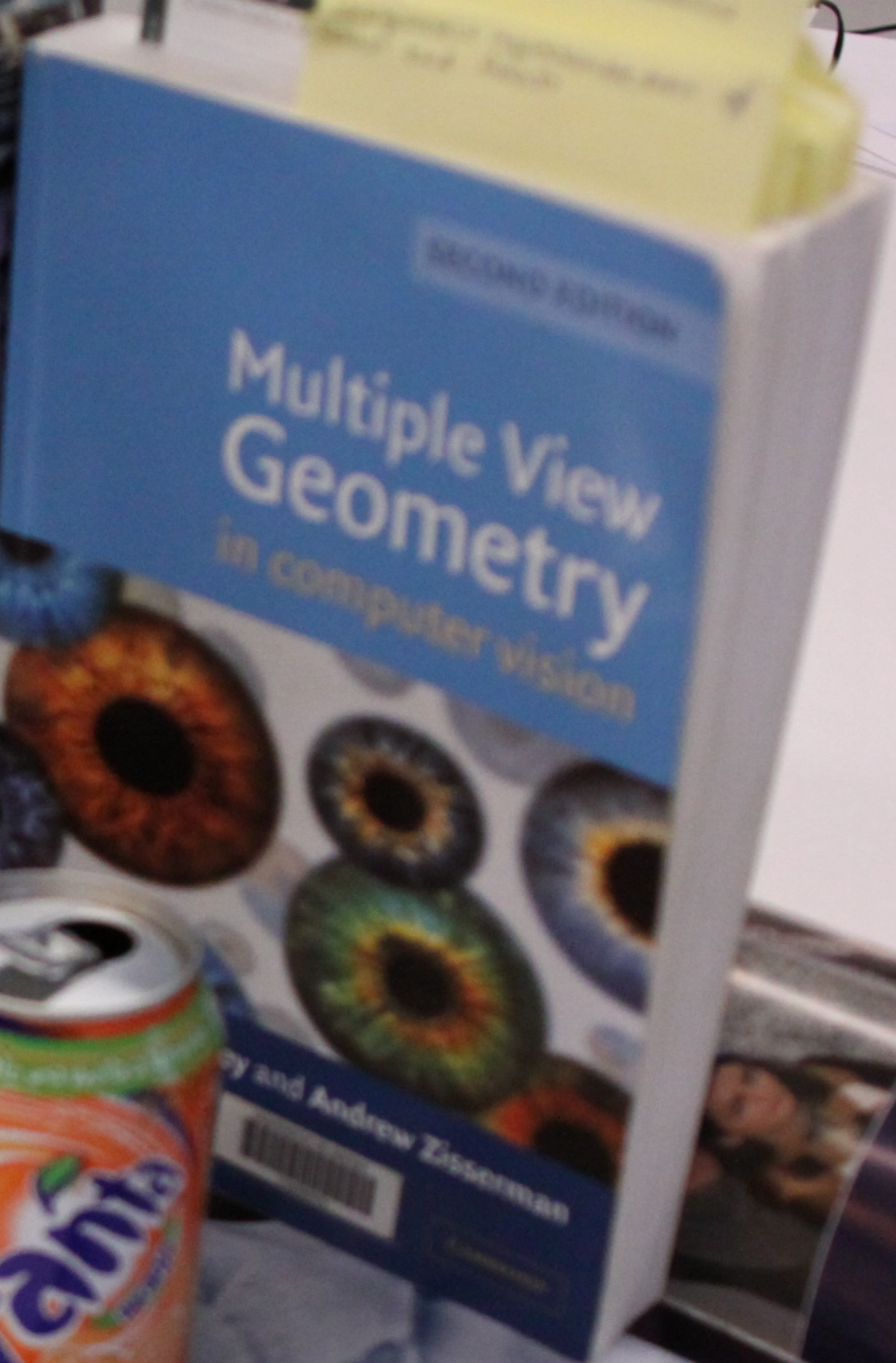
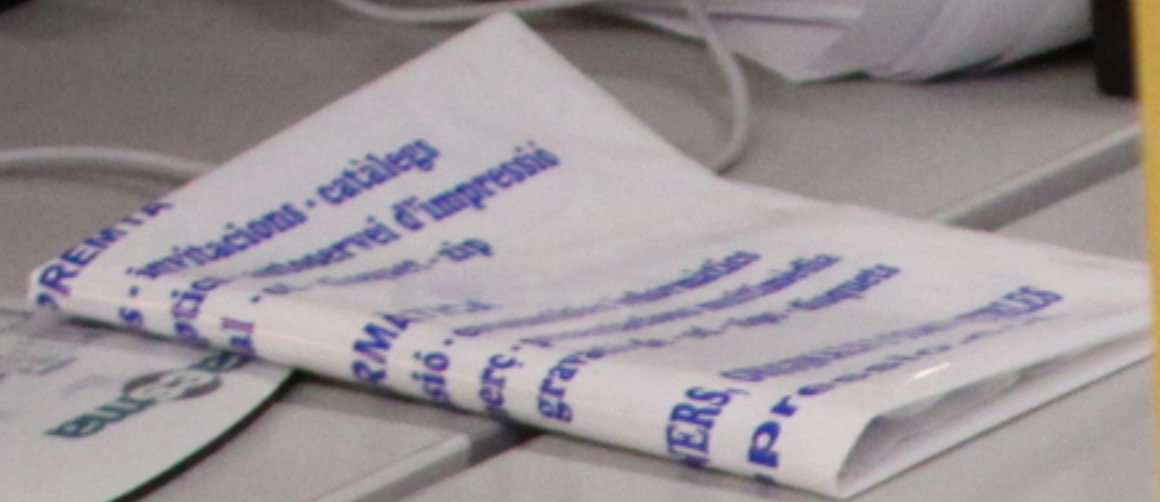

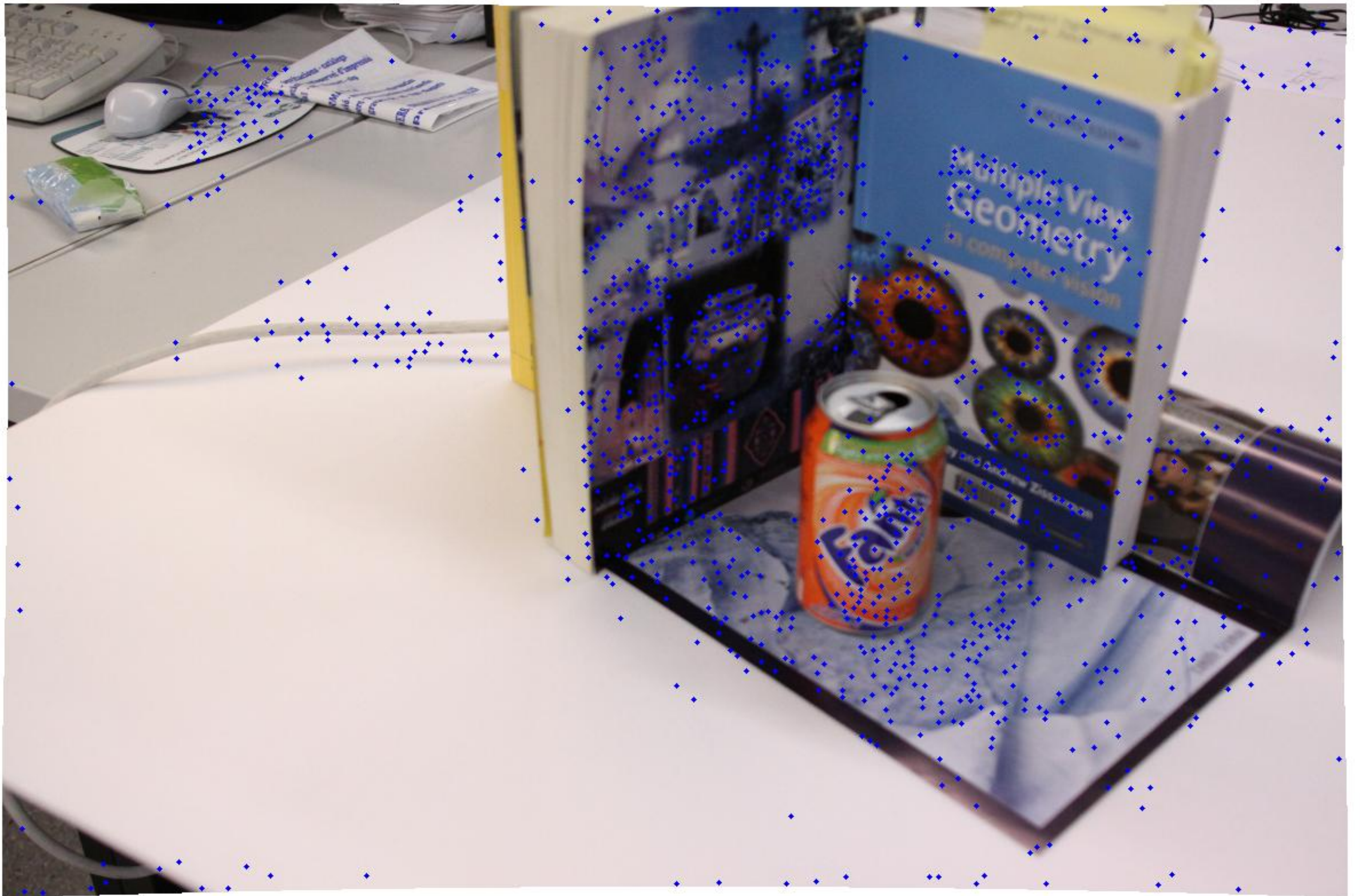

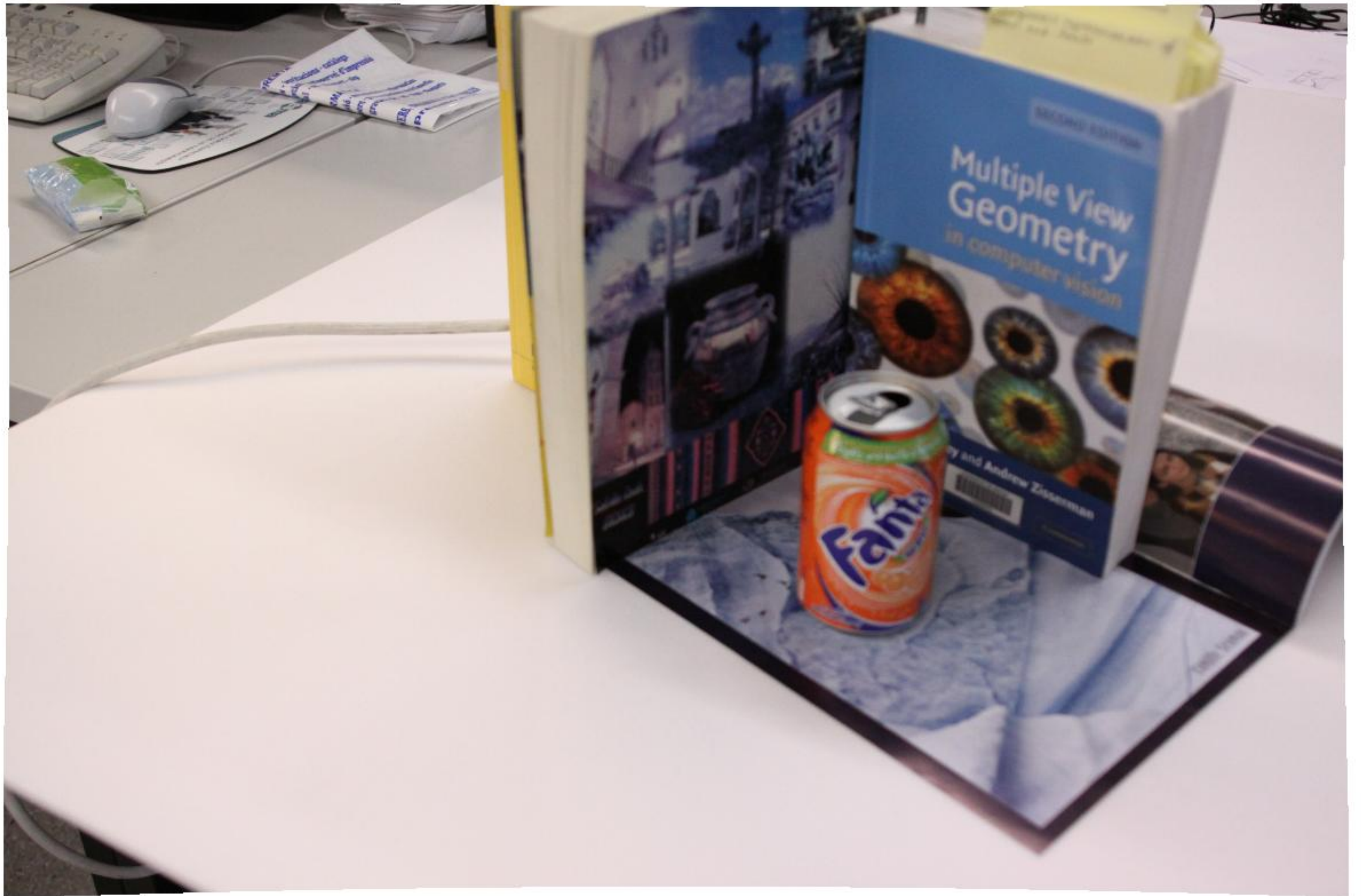



656692-0000

Logitech

Logitech

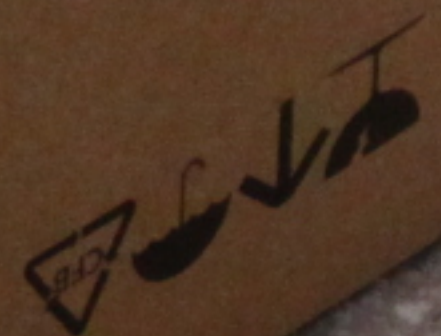





656692-0000

Logitech
i

Logitech
i









656692-0000

Logitech



Logitech



Logitech

656692-0000

